

# Sterilization Container Systems

---

Secure Today  
Elevate Tomorrow

---

 Different  
Colors



 **VICTORIS**



Victoris retains the right to modify and enhance the products showcased in this catalogue as part of ongoing development efforts. All provided weight and dimensional information are approximate and may vary from the actual products.

Copyright © Victoris Co., Inc. All Rights Reserved  
VH-CC-K001 Rev.02

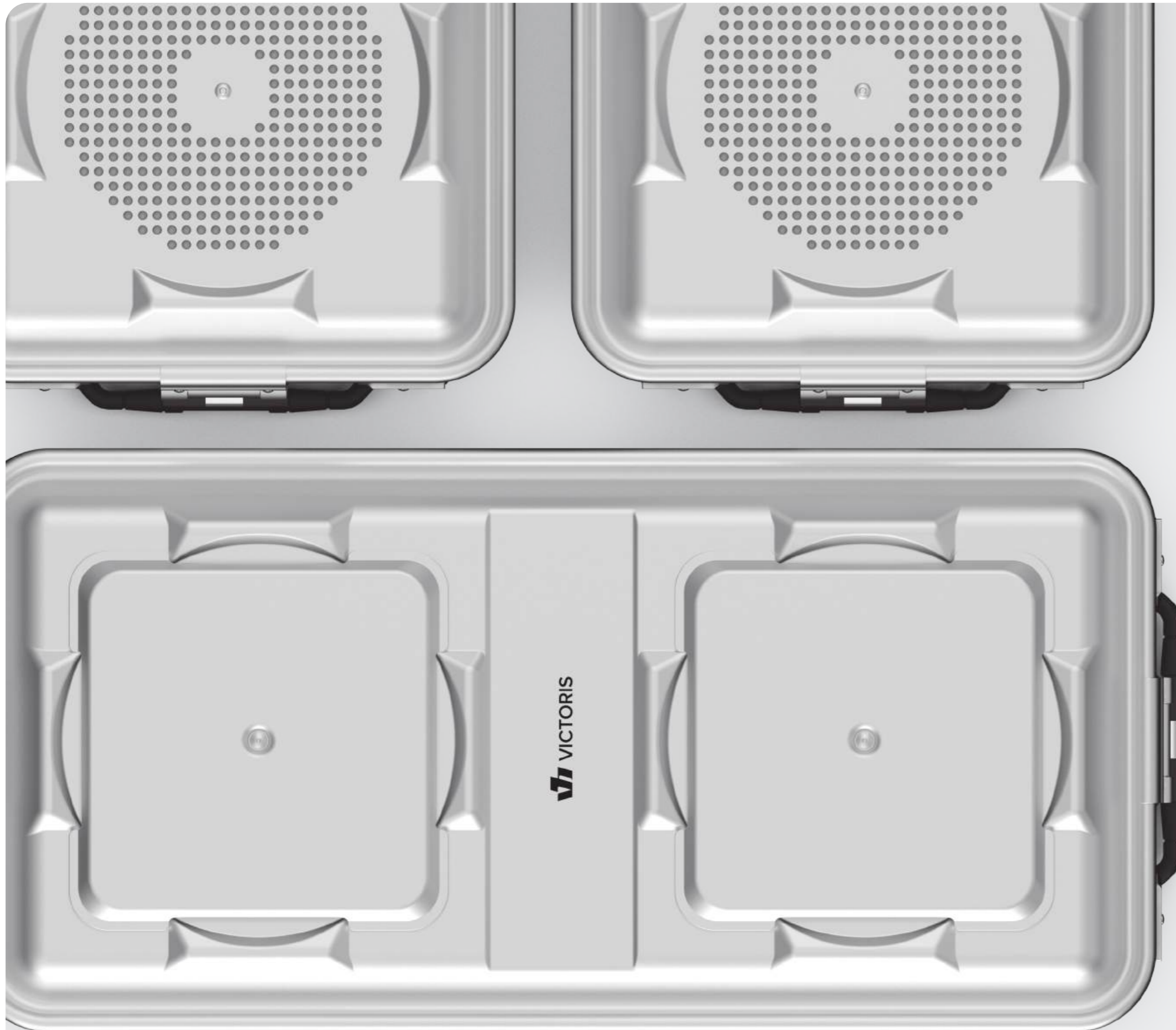

## Table Of Contents

---

<b>06</b>	INTRODUCTION	→	<b>15</b>
<b>16</b>	STANDARD MODELS	→	<b>35</b>
<b>36</b>	REUSABLE MODELS	→	<b>57</b>
<b>58</b>	STERILIZATION BASKETS	→	<b>67</b>
<b>68</b>	ACCESSORIES & COMPONENTS	→	<b>69</b>
<b>70</b>	TROLLEYS & TABLES	→	<b>71</b>
<b>72</b>	INDEX	→	<b>73</b>

## The Full Story

Victoris is more than a healthcare supply company; it's a testament to resilience, integrity, and a commitment to human values. Founded by two industry professionals who shared a vision for a workplace that prioritizes people over profit, our story began in the halls of an international medical device company. In the face of adversity, to create a company that not only thrives in the industry but serves as a beacon of compassion and ethical leadership. Victoris was born from the belief that success is measured not just in financial gains but in the positive impact a company can have on its employees and the community it serves.



### Our Vision

At Victoris, our vision is to be a leader in healthcare solutions, recognized not only for the quality of our products but for the unwavering commitment to the well-being of our employees and the communities we serve. We envision a future where healthcare is not only about cutting-edge technology but also about compassionate and ethical practices, setting a benchmark for the industry.

### Our Mission

Our mission at Victoris is twofold. Firstly, to provide exceptional healthcare products that enhance the lives of individuals undergoing medical procedures, for humans or pets. Secondly, to pioneer a corporate culture that prioritizes the welfare of our team members, recognizing them as the driving force behind our success. We are dedicated to fostering an environment that values diversity, upholds human rights, and serves as a beacon for responsible and ethical business practices.

## Precision in Form, Compliance in Function

### R&D

Experience the innovation driving Victoris with our dedicated Research and Development (R&D) division. Our R&D team is committed to pushing the boundaries of healthcare technology, continually developing breakthrough solutions to meet the evolving needs of the industry.

Utilizing cutting-edge technologies and advanced methodologies, our focus on rigorous testing and constant improvement ensures that each product meets the highest standards of quality and reliability. Trust in our relentless pursuit of excellence to elevate your operations and achieve unparalleled performance.

### Production

Discover the excellence of Victoris production processes, designed to ensure precision, efficiency, and unparalleled quality. Our advanced production techniques are meticulously developed to deliver consistent results, ensuring that every product meets the highest standards of safety and reliability.

Spanning a closed production area of 2000 square meters, we leverage innovative technologies and streamlined workflows to minimize downtime and enhance productivity. Trust in our expertise to maintain the utmost quality and reliability in every aspect of your operations.

### Regulatory / Quality

At Victoris, our unwavering commitment to quality, safety, and compliance, including adherence to regulatory bodies such as CE, FDA, and ISO, is the driving force behind everything we do. Our Regulatory Affairs and Quality Assurance department, at the heart of our operations, ensures that our products consistently meet the highest industry standards and comply with all relevant guidelines.

We understand that in the medical industry, quality is non-negotiable, which is why our RA/QA team is dedicated to upholding the most rigorous standards of product quality, safety, and effectiveness, leaving no stone unturned to meet or exceed the stringent requirements of the healthcare and veterinary sectors.

Navigating the complex landscape of regulatory compliance is essential, and our experienced regulatory affairs professionals stay up to date with the latest regulations, working diligently to secure the necessary approvals, certifications, and registrations from CE, FDA, ISO, and other relevant authorities.

Furthermore, our commitment to Occupational Health and Safety Policy is integral to our operations, ensuring the well-being of our workforce and the quality of our products.

### Technical Competencies

- Machining
- Subtractive Manufacturing
- Deep Drawing
- Die & Mold Making
- Chemical Coating
- Hard Anodization
- Silicone Forming
- Laser Welding
- OEM - ODM - PLM



Special Stackability Design



Place and Go Gasket

Shape / No Glue

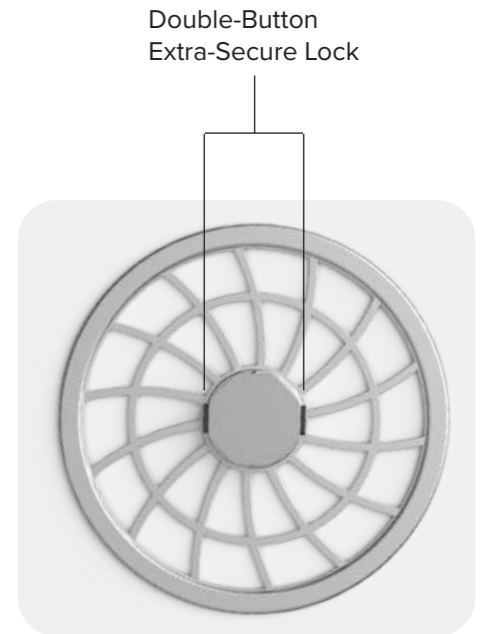

Double-Button  
Extra-Secure Lock

Filter Retainer With  
Sealing & Spring System

2 mm Aluminium  
Bottom & Lid

Spring-Loaded Aluminium  
Lock for  
Better Grip and Sealing

Face Plate Made of  
Single Block of Aluminium

Extra-Strong Silicone Coated  
Ergonomic Handles

OEM-PLM  
Marking Option





## Different Lids Colors

Our sterilization containers at Victoris come in eight different colors (silver, yellow, red, blue, green, black, bronze and purple) ensuring to easily distinguish between different sets or types of instruments at a glance.



### Advantages of Multiple Colors

- Enhanced Organization: Different colors can be used to categorize and organize instruments based on their usage, department, or level of sterilization, reducing the risk of cross-contamination and improving efficiency..
- Easy Identification: Color-coding helps in quickly identifying the contents of each container, saving time and reducing errors in busy environments.
- Improved Workflow: With a clear visual system in place, staff can more easily manage inventory and ensure that the right instruments are always in the right place.

## Customized Solutions & Tailored to Your Needs

Victoris sterilization containers are manufactured in 8 main sizes to accommodate various surgical needs: standard sizes (1/1 Full Size, 3/4 Quarter Size, 1/2 Half Size, Mini, Dental and 1/2 Dental Size) are ideal for common instrument sets, while the Wide Body size suits specialized instruments like Bookwalter retractors, and the Long Body size is designed for extended instruments such as robotic arms.

The sterilization containers are crafted in five primary heights to suit a variety of surgical instruments. Additionally, custom sizes or heights can be tailored to meet specific requirements.

Standard 5 Different Heights For Standard & Reusable Models

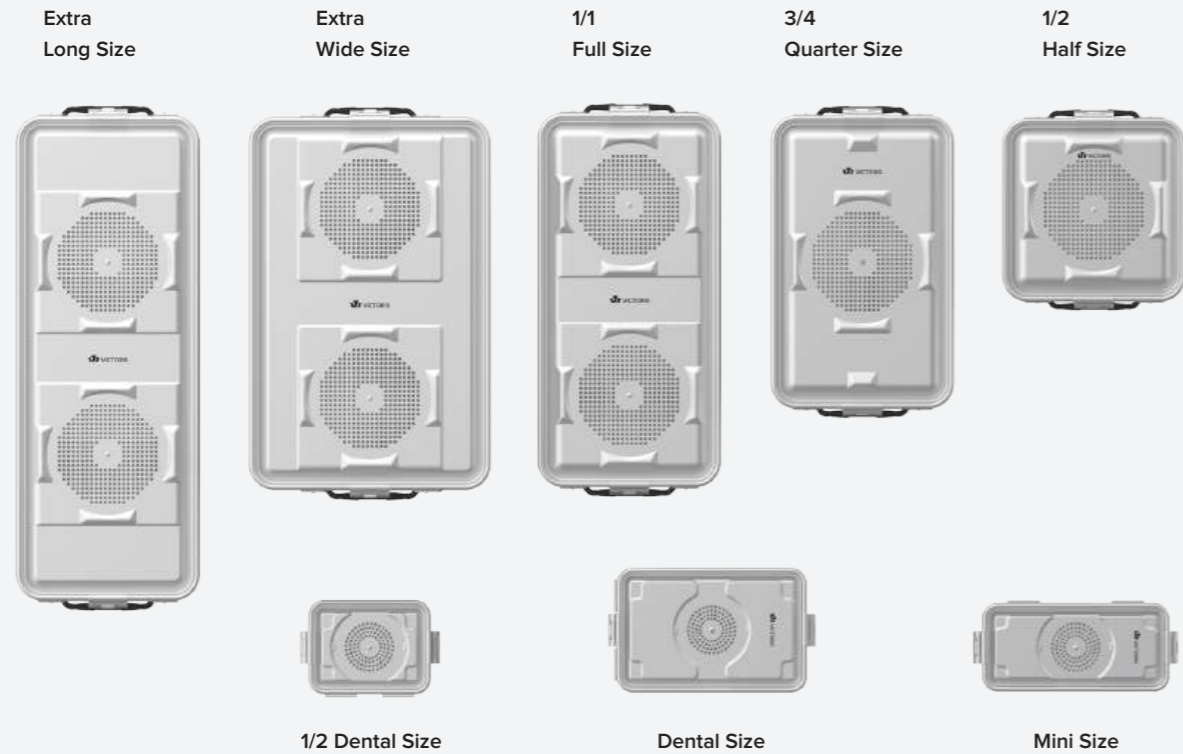

Standard 8 Different Size Types For Standard & Reusable Models

Type	Packaging according to EN 868-8		Steam sterilization procedure according to EN 285				
	Description	Symbolic Packaging	Gravity	Pre-Vacuum	Fractional Vacuum	Fractional Flow	Steam Injection
Sterilization Container with filters	Textiles in container with filter in lid and box		+	+	+	+	+
			O	O	+	+	+
	Textiles in container with filter in lid, non-perforated box		-	-	+	+	+
			-	-	+	+	O
	Textiles in container with filter in box, non-perforated lid		O	+	+	+	+
			-	O	+	+	+
	Instruments in wire basket, in sterilization filter in lid and box		+3	+	+	+	+
Instruments in wire basket, in sterilization container filter in lid and non-perforated box		-	+2	+2	+2	+2	
Instruments in wire basket, in sterilization container filter in box and non-perforated lid		O	+	+	+	+	
Sterilization Container with valves	Textiles in sterilization container with valves in lid and box		-	O	+	+	O
			-	-	+	+	O
	Textiles in sterilization container with valves in lid and no valves on the box		-	-	+	+	-
			-	-	+	+	-
	Instruments in wire basket in sterilization container with valve in lid and box		-	+2	+2	+2	+2
Instruments in wire basket, in sterilization container with valve in lid and non-perforated box		-	+2	+2	+2	+2	

\*To prevent errors during service, operation, or loading of the autoclaves, consult above table.  
 \*Use only sterilization containers that guarantee proper evaporation or discharge of condensate.  
 \*Keep in mind that gravitation-based procedures, which lack a dedicated drying process, do not ensure sufficient after-drying effects.

# STANDARD & REUSABLE MODELS

SECURE TODAY

ELEVATE TOMORROW



## WHY STERILIZATION CONTAINERS?

- Consistent Processing
- Reduced Risk of Contamination
- Physical Instrument Protection
- Optimal Set Organization
- Reusability / Sustainability
- Reduced Waste
- Streamlined Process
- Easy Identification and Access
- Adherence to Standards
- Minimized Handling

# Today's Safety. Tomorrow's Efficiency



## Elevated Sterilization Solutions: For Your Operational Excellence

Discover our 2mm special alloy aluminum container systems that provide superior protection for your surgical instruments. Available in 8 different color palettes, they facilitate organization and quick identification. This solution supports your operational excellence by combining reliability, an eco-friendly approach, and long-term cost advantages.

**SAFETY LIDS**

**TWO DIFFERENT FILTER TYPES**  
Paper Filter or PTFE Filter

**EASE WITH COLORS**  
EXCELLENCE IN WORKFLOW

Different Lids Colors

**TWO BOTTOM TYPES**

Non Perforated Perforated

## Standard Model

1/1 Full Size

 Different Lids Colors



With Safety Lid



With Perforated Lid



Non Perforated



**Code**      **Outside Dimension**  
**Inside Dimension**  
**L x W x H**

K1-10-110    597 x 275 x 95 mm  
546 x 258 x 9 mm

K1-10-135    597 x 275 x 120 mm  
546 x 258 x 115 mm

K1-10-150    597 x 275 x 136 mm  
546 x 258 x 131 mm

K1-10-200    597 x 275 x 188 mm  
546 x 258 x 183 mm

K1-10-260    597 x 275 x 235 mm  
546 x 258 x 230 mm



Perforated



**Code**      **Outside Dimension**  
**Inside Dimension**  
**L x W x H**

KP1-10-110    597 x 275 x 95 mm  
544 x 257 x 75 mm

KP1-10-135    597 x 275 x 120 mm  
544 x 257 x 100 mm

KP1-10-150    597 x 275 x 136 mm  
544 x 257 x 116 mm

KP1-10-200    597 x 275 x 188 mm  
544 x 257 x 168 mm

KP1-10-260    597 x 275 x 235 mm  
544 x 257 x 215 mm



Lids



**Colors**    **Code**

Grey    K1-10-1  
Yellow    K1-10-2  
Red    K1-10-3  
Blue    K1-10-4  
Green    K1-10-5  
Black    K1-10-6  
Purple    K1-10-7  
Bronze    K1-10-8

**Dimension**  
585 x 285 x 37 mm



Safety Lids



**Colors**    **Code**

Grey    KS1-10-1  
Yellow    KS1-10-2  
Red    KS1-10-3  
Blue    KS1-10-4  
Green    KS1-10-5  
Black    KS1-10-6  
Purple    KS1-10-7  
Bronze    KS1-10-8

**Dimension**  
586 x 289 x 36 mm

### Wire Basket



Mesh: 4x4 mm  
Wire: ø 1 mm

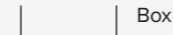

Box

Code	Outside Dimension L x W x H
B1-5425-30	540 x 245 x 30 mm
B1-5425-50	540 x 245 x 50 mm
B1-5425-70	540 x 245 x 70 mm
B1-5425-100	540 x 245 x 100 mm



Lid

Code	Outside Dimension L x W x H
B1-5425	510 x 230 x 5 mm

### Perforated Basket



Mesh: 4x4 mm  
Wire: ø 1 mm

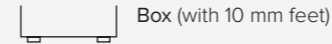

Box (with 10 mm feet)

Code	Outside Dimension L x W x H
B2-5425-30	540 x 251 x 40 mm
B2-5425-50	540 x 251 x 60 mm
B2-5425-70	540 x 251 x 80 mm
B2-5425-100	540 x 251 x 110 mm



Lid

Code	Outside Dimension L x W x H
B2-5425	540 x 256 x 5 mm

### Hybrid Basket



Mesh: 4x4 mm  
Sides: ø 3 mm  
Wire: ø 1 mm

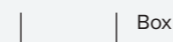

Box

Code	Outside Dimension L x W x H
B3-5425-50	540 x 255 x 50 mm
B3-5425-70	540 x 255 x 70 mm
B3-5425-100	540 x 255 x 100 mm

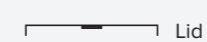

Lid

Code	Outside Dimension L x W x H
B3-5425	510 x 240 x 5 mm

### Silicone Mat

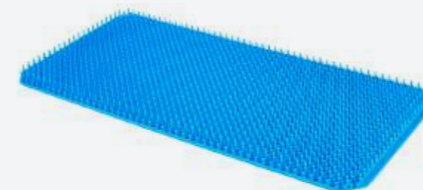

Code	Outside Dimension L x W x H
A7-5425	500 x 235 mm

## Standard Model

1/1 Full Size Baskets

### Wire Basket



### Perforated Basket

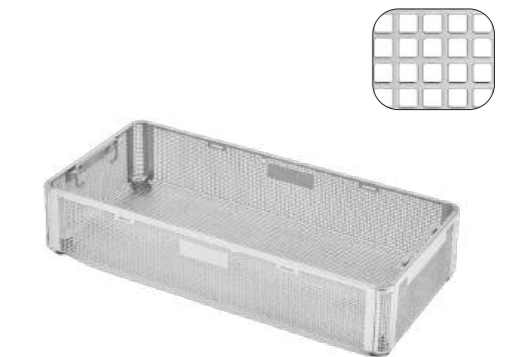

### Hybrid Basket



## Standard Model

3/4 Quarter Size

 Different Lids Colors



With Safety Lid



With Perforated Lid



Non Perforated



**Code**      **Outside Dimension**  
**Inside Dimension**  
**L x W x H**

K1-20-110    477 x 275 x 95 mm  
423 x 258 x 90 mm

K1-20-135    477 x 275 x 120 mm  
423 x 258 x 115 mm

K1-20-150    477 x 275 x 136 mm  
423 x 258 x 131 mm

K1-20-200    477 x 275 x 188 mm  
423 x 258 x 183 mm



Perforated



**Code**      **Outside Dimension**  
**Inside Dimension**  
**L x W x H**

KP1-20-110    477 x 275 x 95 mm  
423 x 258 x 75 mm

KP1-20-135    477 x 275 x 120 mm  
423 x 258 x 100 mm

KP1-20-150    477 x 275 x 136 mm  
423 x 258 x 116 mm

KP1-20-200    477 x 275 x 188 mm  
423 x 258 x 168 mm



Lids



**Colors**    **Code**

Grey    K1-20-1  
Yellow    K1-20-2  
Red    K1-20-3  
Blue    K1-20-4  
Green    K1-20-5  
Black    K1-20-6  
Purple    K1-20-7  
Bronze    K1-20-8

**Dimension**  
465 x 280 x 37 mm



Safety Lids



**Colors**    **Code**

Grey    KS1-20-1  
Yellow    KS1-20-2  
Red    KS1-20-3  
Blue    KS1-20-4  
Green    KS1-20-5  
Black    KS1-20-6  
Purple    KS1-20-7  
Bronze    KS1-20-8

**Dimension**  
482 x 289 x 36 mm

### Wire Basket



Mesh: 4x4 mm  
Wire: ø 1 mm

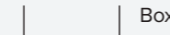

Box

Code	Outside Dimension L x W x H
B1-4025-30	405 x 245 x 30 mm
B1-4025-50	405 x 245 x 50 mm
B1-4025-70	405 x 245 x 70 mm
B1-4025-100	405 x 245 x 100 mm



Lid

Code	Outside Dimension L x W x H
B1-4025	375 x 230 x 5 mm

### Perforated Basket



Mesh: 4x4 mm  
Wire: ø 1 mm

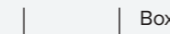

Box (with 10 mm feet)

Code	Outside Dimension L x W x H
B2-4025-30	403 x 251 x 40 mm
B2-4025-50	403 x 251 x 60 mm
B2-4025-70	403 x 251 x 80 mm
B2-4025-100	403 x 251 x 110 mm



Lid

Code	Outside Dimension L x W x H
B2-4025	405 x 256 x 5 mm

### Hybrid Basket



Mesh: 4x4 mm  
Sides: ø 3 mm  
Wire: ø 1 mm

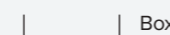

Box

Code	Outside Dimension L x W x H
B3-4025-50	405 x 255 x 50 mm
B3-4025-70	405 x 255 x 70 mm
B3-4025-100	405 x 255 x 100 mm



Lid

Code	Outside Dimension L x W x H
B3-4025	375 x 240 x 5 mm

### Silicone Mat

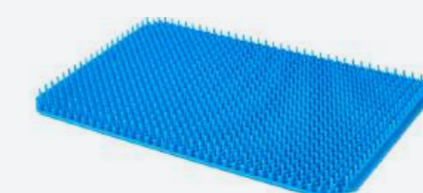

**Code**  
A7-4025  
**Outside Dimension**  
L x W x H  
370 x 235 mm

## Standard Model

3/4 Quarter Size Baskets

### Wire Basket



### Perforated Basket



### Hybrid Basket



## Standard Model

1/2 Half Size

Different Lids Colors



With Safety Lid



With Perforated Lid



Non Perforated



**Code**      **Outside Dimension**  
**Inside Dimension**  
**L x W x H**

K1-30-110    307 x 275 x 95 mm  
258 x 258 x 90 mm

K1-30-135    307 x 275 x 120 mm  
258 x 258 x 115 mm

K1-30-150    307 x 275 x 136 mm  
258 x 258 x 131 mm

K1-30-200    307 x 275 x 188 mm  
258 x 258 x 183 mm

K1-30-260    307 x 275 x 235 mm  
258 x 258 x 230 mm



Perforated



**Code**      **Outside Dimension**  
**Inside Dimension**  
**L x W x H**

KP1-30-110    307 x 275 x 95 mm  
258 x 258 x 75 mm

KP1-30-135    307 x 275 x 120 mm  
258 x 258 x 100 mm

KP1-30-150    307 x 275 x 136 mm  
258 x 258 x 116 mm

KP1-30-200    307 x 275 x 188 mm  
258 x 258 x 168 mm

KP1-30-260    307 x 275 x 235 mm  
258 x 258 x 215 mm

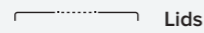

Lids



**Colors**    **Code**

Grey    K1-30-1  
Yellow    K1-30-2  
Red    K1-30-3  
Blue    K1-30-4  
Green    K1-30-5  
Black    K1-30-6  
Purple    K1-30-7  
Bronze    K1-30-8

**Dimension**  
295 x 280 x 37 mm



Safety Lids



**Colors**    **Code**

Grey    KS1-30-1  
Yellow    KS1-30-2  
Red    KS1-30-3  
Blue    KS1-30-4  
Green    KS1-30-5  
Black    KS1-30-6  
Purple    KS1-30-7  
Bronze    KS1-30-8

**Dimension**  
295 x 289 x 36 mm

### Wire Basket



Mesh: 4x4 mm  
Wire: ø 1 mm

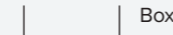

Box

Code	Outside Dimension L x W x H
B1-2525-30	246 x 246 x 30 mm
B1-2525-50	246 x 246 x 50 mm
B1-2525-70	246 x 246 x 70 mm
B1-2525-100	246 x 246 x 100 mm



Lid

Code	Outside Dimension L x W x H
B1-2525	240 x 215 x 5 mm

### Perforated Basket



Mesh: 4x4 mm  
Wire: ø 1 mm

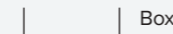

Box (with 10 mm feet)

Code	Outside Dimension L x W x H
B2-2525-30	244 x 250 x 40 mm
B2-2525-50	244 x 250 x 60 mm
B2-2525-70	244 x 250 x 80 mm
B2-2525-100	244 x 250 x 110 mm



Lid

Code	Outside Dimension L x W x H
B2-2525	247 x 256 x 5 mm

### Hybrid Basket



Mesh: 4x4 mm  
Sides: ø 3 mm  
Wire: ø 1 mm

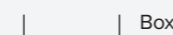

Box

Code	Outside Dimension L x W x H
B3-2525-50	245 x 255 x 50 mm
B3-2525-70	245 x 255 x 70 mm
B3-2525-100	245 x 255 x 100 mm



Lid

Code	Outside Dimension L x W x H
B3-2525	215 x 240 x 5 mm

### Silicone Mat



Code	Outside Dimension L x W x H
A7-2525	225 x 235 mm

## Standard Model

1/2 Half Size Baskets

### Wire Basket

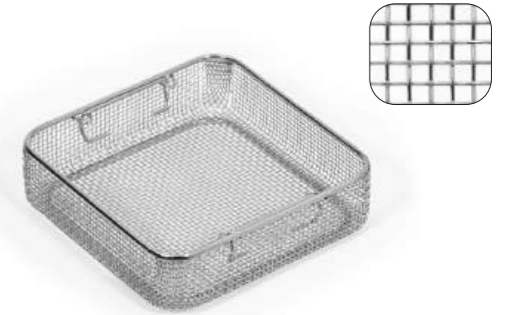

### Perforated Basket

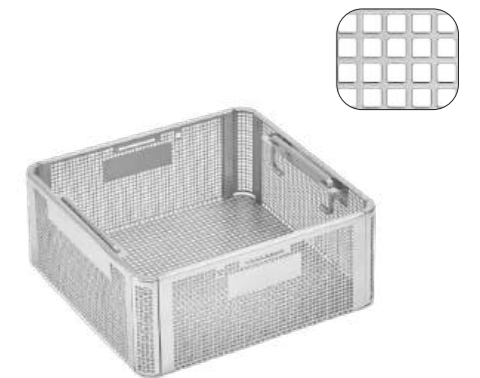

### Hybrid Basket



## Standard Model

Long Size

 Different Lids Colors



With Perforated Lid



With Color Options



Non Perforated



**Code**      **Outside Dimension**  
**Inside Dimension**  
**L x W x H**

K1-40-150    770 x 275 x 136 mm  
715 x 258 x 131 mm

K1-40-200    770 x 275 x 188 mm  
715 x 258 x 183 mm



Perforated



**Code**      **Outside Dimension**  
**Inside Dimension**  
**L x W x H**

KP1-40-150    770 x 275 x 136 mm  
715 x 258 x 116 mm

KP1-40-200    770 x 275 x 188 mm  
715 x 258 x 168 mm

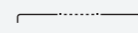
 Lids

**Colors**    **Code**

Grey      K1-40-1

Yellow    K1-40-2

Red        K1-40-3

Blue       K1-40-4

Green     K1-40-5

Black      K1-40-6

Purple    K1-40-7

Bronze    K1-40-8

**Dimension**  
758 x 280 x 37 mm



### Wire Basket



 Box

**Code**      **Outside Dimension**  
**L x W x H**

B1-6625-50    665 x 245 x 50 mm

B1-6625-70    665 x 245 x 70 mm

B1-6625-100   665 x 245 x 100 mm

Mesh: 4x4 mm  
Wire: ø 1 mm

 Lid

**Code**  
B1-6625

**Outside Dimension**  
**L x W x H**

635 x 230 x 5 mm

### Perforated Basket

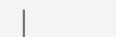

 Box (with 10 mm feet)

**Code**      **Outside Dimension**  
**L x W x H**

B2-6625-30    650 x 251 x 40 mm

B2-6625-50    650 x 251 x 60 mm

B2-6625-70    650 x 251 x 80 mm

B2-6625-100   650 x 251 x 110 mm

Mesh: 4x4 mm  
Wire: ø 1 mm

 Lid

**Code**  
B2-6625

**Outside Dimension**  
**L x W x H**

652 x 256 x 5 mm

### Hybrid Basket

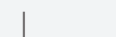

 Box

**Code**      **Outside Dimension**  
**L x W x H**

B3-6625-50    665 x 255 x 50 mm

B3-6625-70    665 x 255 x 70 mm

B3-6625-100   665 x 255 x 100 mm

Mesh: 4x4 mm  
Sides: ø 3 mm  
Wire: ø 1 mm

 Lid

**Code**  
B3-6625

**Outside Dimension**  
**L x W x H**

635 x 240 x 5 mm

## Standard Model

Long Size Baskets

### Wire Basket

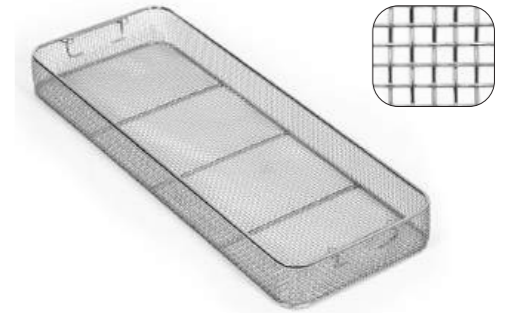

### Perforated Basket

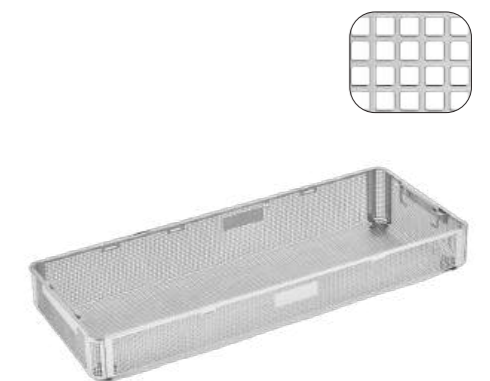

### Hybrid Basket



## Standard Model

Wide Size

 Different Lids Colors



With Perforated Lid



With Color Options



Non Perforated



**Code**      **Outside Dimension**  
**Inside Dimension**  
**L x W x H**

K1-50-110    597 x 365 x 105 mm  
546 x 348 x 100 mm

K1-50-170    597 x 365 x 165 mm  
546 x 348 x 160 mm



Perforated



**Code**      **Outside Dimension**  
**Inside Dimension**  
**L x W x H**

KP1-50-110    597 x 365 x 105 mm  
546 x 348 x 85 mm

KP1-50-170    597 x 365 x 165 mm  
546 x 348 x 145 mm

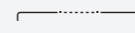
 Lids

**Colors**    **Code**

Grey      K1-50-1

Yellow    K1-50-2

Red        K1-50-3

Blue       K1-50-4

Green     K1-50-5

Black      K1-50-6

Purple    K1-50-7

Bronze    K1-50-8

**Dimension**  
585 x 370 x 37 mm



### Wire Basket



Mesh: 4x4 mm  
Wire: ø 1 mm

 Box

 Lid

**Code**      **Outside Dimension**  
**L x W x H**

B1-5333-50    533 x 337 x 50 mm

B1-5333-70    533 x 337 x 70 mm

B1-5333-100   533 x 337 x 100 mm

**Code**  
B1-5333

**Outside Dimension**  
**L x W x H**  
503 x 322 x 5 mm

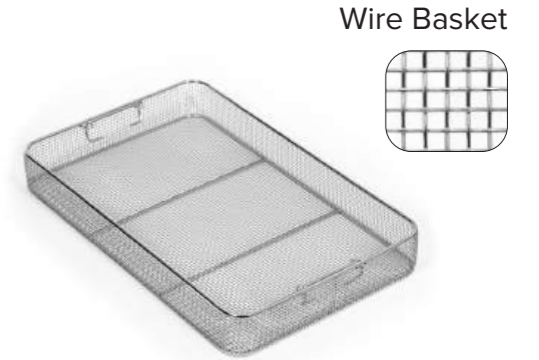

### Perforated Basket

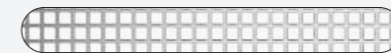

Mesh: 4x4 mm  
Wire: ø 1 mm

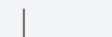
 Box (with 10 mm feet)

 Lid

**Code**      **Outside Dimension**  
**L x W x H**

B2-5333-30    535 x 340 x 40 mm

B2-5333-50    535 x 340 x 60 mm

B2-5333-70    535 x 340 x 80 mm

B2-5333-100   535 x 340 x 110 mm

**Code**  
B2-5333

**Outside Dimension**  
**L x W x H**  
537 x 343 x 5 mm

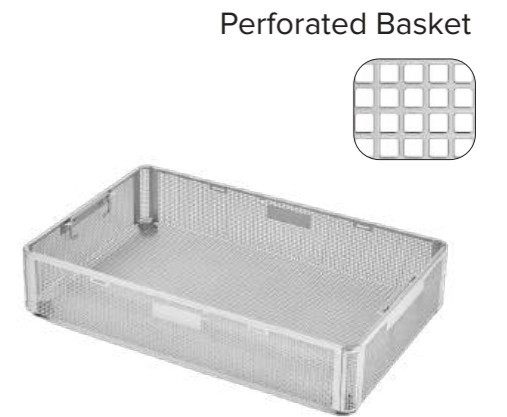

### Hybrid Basket

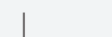

Mesh: 4x4 mm  
Sides: ø 3 mm  
Wire: ø 1 mm

 Box

 Lid

**Code**      **Outside Dimension**  
**L x W x H**

B3-5333-50    533 x 337 x 50 mm

B3-5333-70    533 x 337 x 70 mm

B3-5333-100   533 x 337 x 100 mm

**Code**  
B3-5333

**Outside Dimension**  
**L x W x H**  
503 x 322 x 5 mm



## Standard Model

Wide Size Baskets

Wire Basket

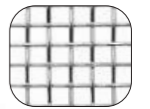

Perforated Basket

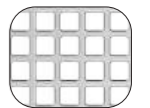

Hybrid Basket

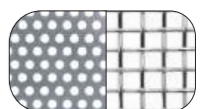

## Standard Model

Flat Size

 Different Lids Colors



With Perforated Lid



With Color Options

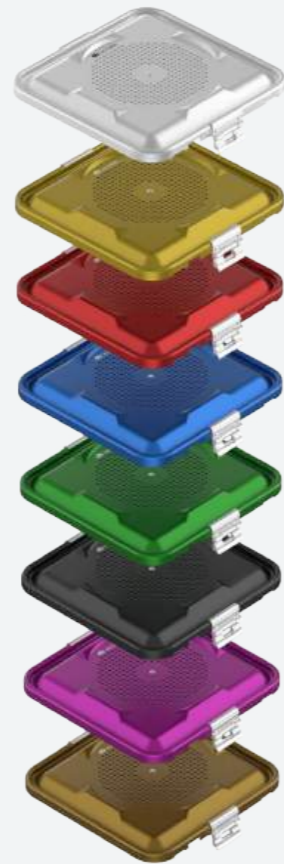

**Code**      **Outside Dimension**  
**Inside Dimension**  
**L x W x H**

K1-90-45    297 x 275 x 55 mm  
258 x 258 x 50 mm

K1-90-75    297 x 275 x 75 mm  
258 x 258 x 70 mm

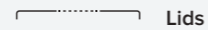

**Colors**    **Code**

Grey    K1-90-1

Yellow    K1-90-2

Red    K1-90-3

Blue    K1-90-4

Green    K1-90-5

Black    K1-90-6

Purple    K1-90-7

Bronze    K1-90-8

**Dimension**  
295 x 280 x 37 mm

### Wire Basket

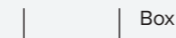

**Code**      **Outside Dimension**  
**L x W x H**

B1-2525-30    246 x 246 x 30 mm

B1-2525-50    246 x 246 x 50 mm

Mesh: 4x4 mm  
Wire: ø 1 mm



**Code**  
B1-2525  
**Outside Dimension**  
**L x W x H**  
240 x 215 x 5 mm

### Perforated Basket

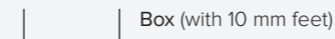

**Code**      **Outside Dimension**  
**L x W x H**

B2-2525-30    244 x 250 x 40 mm

B2-2525-50    244 x 250 x 60 mm

Mesh: 4x4 mm  
Wire: ø 1 mm



**Code**  
B2-2525  
**Outside Dimension**  
**L x W x H**  
247 x 256 x 5 mm

### Silicone Mat



**Code**  
A7-2525  
**Outside Dimension**  
**L x W x H**  
225 x 235 mm

## Standard Model

Flat Size Baskets

### Wire Basket

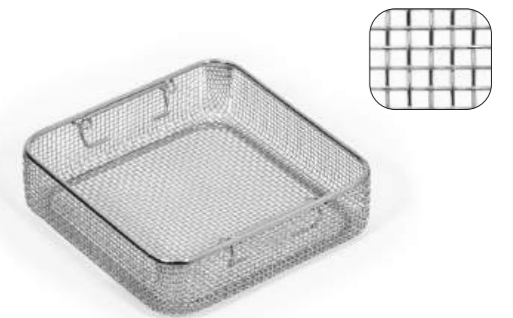

### Perforated Basket

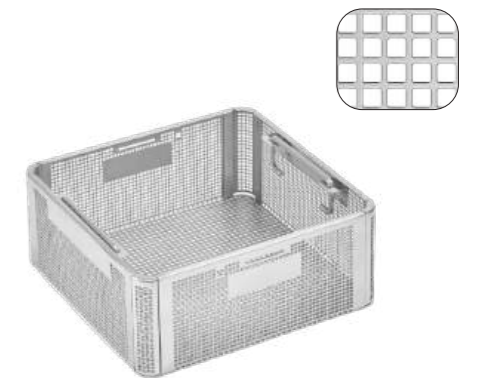

## Standard Model

### Mini Size

 Different Lids Colors



With Perforated Lid



With Color Options



**Code**      **Outside Dimension**  
**Inside Dimension**  
**L x W x H**

K1-70-40	305 x 135 x 45 mm 272 x 125 x 33 mm
K1-70-70	305 x 135 x 60 mm 272 x 125 x 48 mm
K1-70-100	305 x 135 x 90 mm 272 x 125 x 78 mm
K1-70-130	305 x 135 x 120 mm 272 x 125 x 108 mm



Colors	Code
Grey	K1-70-1
Yellow	K1-70-2
Red	K1-70-3
Blue	K1-70-4
Green	K1-70-5
Black	K1-70-6
Purple	K1-70-7
Bronze	K1-70-8

**Dimension**  
303 x 136 x 29 mm

### Wire Basket



Mesh: 4x4 mm  
Wire: ø 1 mm



Code	Outside Dimension L x W x H
B1-2712-40	268 x 117 x 40 mm
B1-2712-100	268 x 117 x 100 mm



Code	Outside Dimension L x W x H
B1-2712	250 x 120 x 5 mm

### Perforated Basket



Mesh: 4x4 mm  
Wire: ø 1 mm

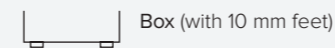

Code	Outside Dimension L x W x H
B2-2712-40	260 x 120 x 50 mm
B2-2712-100	260 x 120 x 110 mm



Code	Outside Dimension L x W x H
B2-2712	262 x 122 x 5 mm

### Silicone Mat



Code	Outside Dimension L x W x H
A7-2712	270 x 125 mm

## Standard Model

### Mini Size Baskets

#### Wire Basket



#### Perforated Basket

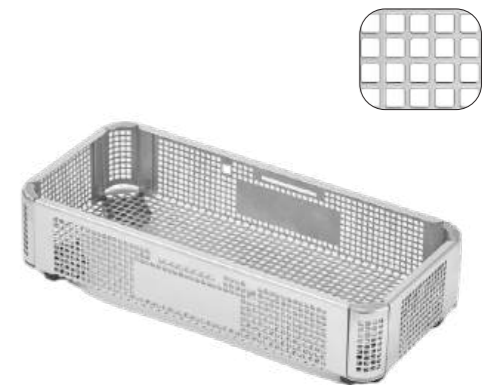

## Standard Model

Dental Size

 Different Lids Colors



With Perforated Lid



With Color Options



**Code**      **Outside Dimension**  
**Inside Dimension**  
**L x W x H**

K1-60-40	310 x 189 x 45 mm 277 x 180 x 33 mm
K1-60-70	310 x 189 x 60 mm 277 x 180 x 48 mm
K1-60-100	310 x 189 x 90 mm 277 x 180 x 78 mm
K1-60-130	310 x 189 x 120 mm 277 x 180 x 108 mm



Colors	Code
Grey	K1-60-1
Yellow	K1-60-2
Red	K1-60-3
Blue	K1-60-4
Green	K1-60-5
Black	K1-60-6
Purple	K1-60-7
Bronze	K1-60-8

**Dimension**  
308 x 190 x 29 mm

### Wire Basket



Mesh: ø 4x4 mm  
Wire: ø 1 mm

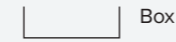

Code	Outside Dimension L x W x H
B1-2717-40	270 x 170 x 40 mm
B1-2717-100	270 x 170 x 100 mm



**Code**  
B1-2717  
**Outside Dimension**  
**L x W x H**  
252 x 172 x 5 mm

### Perforated Basket



Mesh: ø 4x4 mm  
Wire: ø 1 mm

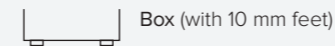

Code	Outside Dimension L x W x H
B2-2717-40	273 x 172 x 50 mm
B2-2717-100	273 x 172 x 110 mm



**Code**  
B2-2717  
**Outside Dimension**  
**L x W x H**  
275 x 174 x 5 mm

## Standard Model

Dental Size Baskets

### Wire Basket

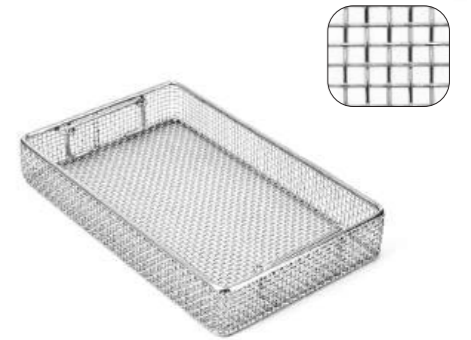

### Perforated Basket



## Standard Model

1/2 Dental Size

 Different Lids Colors



With Perforated Lid



With Color Options



**Code**      **Outside Dimension**  
**Inside Dimension**  
**L x W x H**

K1-80-40	207 x 144 x 45 mm 174 x 135 x 33 mm
K1-80-70	207 x 144 x 60 mm 174 x 135 x 48 mm
K1-80-100	207 x 144 x 90 mm 174 x 135 x 78 mm
K1-80-130	207 x 144 x 120 mm 174 x 135 x 108 mm



Colors	Code
Grey	K1-80-1
Yellow	K1-80-2
Red	K1-80-3
Blue	K1-80-4
Green	K1-80-5
Black	K1-80-6
Purple	K1-80-7
Bronze	K1-80-8

**Dimension**  
205 x 145 x 29 mm

### Wire Basket



Mesh: ø 4x4 mm  
Wire: ø 1 mm



**Code**      **Outside Dimension**  
**L x W x H**

B1-1714-40	165 x 130 x 35 mm
B1-1714-100	165 x 130 x 100 mm

**Code**  
B1-1714  
**Outside Dimension**  
**L x W x H**  
147 x 132 x 5 mm



Wire Basket

### Perforated Basket



Mesh: ø 4x4 mm  
Wire: ø 1 mm

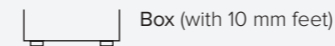

**Code**      **Outside Dimension**  
**L x W x H**

B2-1714-40	165 x 130 x 40 mm
B2-1714-100	165 x 130 x 100 mm

**Code**  
B2-1714  
**Outside Dimension**  
**L x W x H**  
167 x 130 x 5 mm



Perforated Basket

## Standard Model

1/2 Dental Size Baskets

Clean. Safe. **Sustainable.**

2 Different Filtering System  
Mechanical Valve System & Barrier System



Different Lids Colors

**BARRIER MODEL**

The Barrier Model is an innovative sterilization container designed to ensure maximum safety in CSSD workflows. Its labyrinth structure prevents microorganisms from entering, maintaining sterility for extended periods. This design offers reliable, practical, and scientifically proven protection.

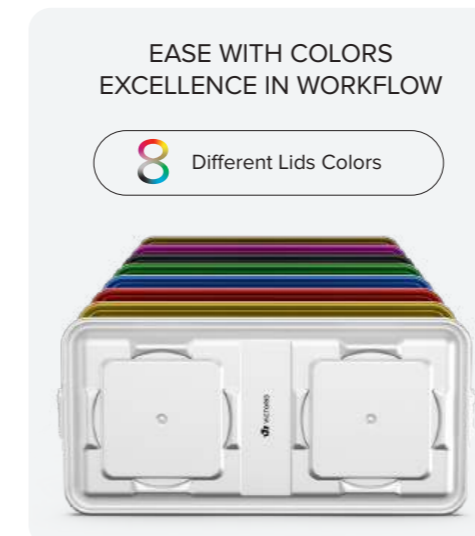
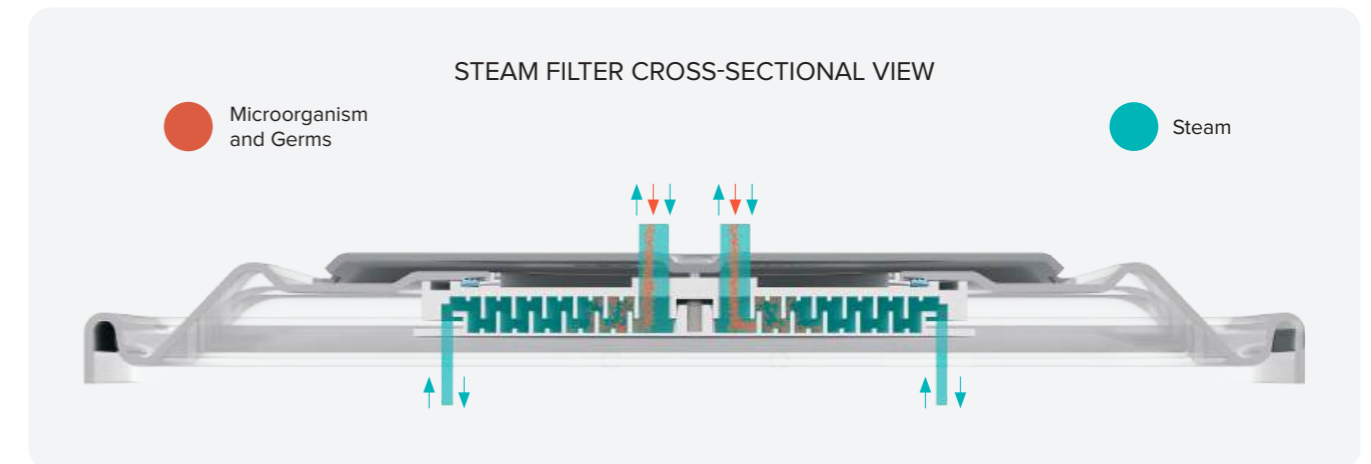

**Scientific Foundation**

The principle behind the Barrier mechanism traces back to Louis Pasteur's groundbreaking "Swan Neck Flask" experiment in 1862, which challenged the idea of spontaneous generation. Pasteur designed a flask with an S-shaped neck that allowed air to pass freely but trapped dust and microorganisms in its curves. When the broth inside was boiled and left untouched, no microbial growth occurred, clearly proving that life could not emerge without contamination from existing microorganisms. However, once the flask was tilted and the trapped particles reached the broth, microbial growth appeared almost immediately.

The Barrier Model adopts the same principle through its labyrinth-like system. By forcing air to travel through a complex path, it prevents microorganisms and viruses from penetrating the container. This ensures that sterility is maintained, while still allowing necessary airflow. The result is a reliable and scientifically validated protective system, directly inspired by one of the most important experiments in microbiology.



**REDUCE. REUSE. RENEW.**

Seize Cost Control and Sustainability: Ditch the waste expense and embrace the smart, permanent solution.

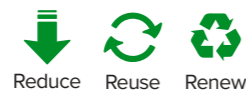

**VALVE MODEL**

Victoris Valve Model sterilization containers are designed with an advanced mechanical valve system that removes the need for disposable filters while delivering stable and reliable performance throughout extended use.

Each valve is precisely engineered with integrated gaskets that ensure smooth operation in response to pressure variations during the sterilization process. The secure closure, supported by high-grade silicone gaskets, provides excellent sealing integrity and long-term durability.

Combining innovative design with practicality, Victoris Valve Model containers offer a sustainable and cost-efficient solution for safe and effective sterilization in healthcare environments worldwide.

EASE WITH COLORS EXCELLENCE IN WORKFLOW

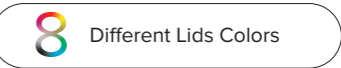

**RUNNING PRINCIPLE**

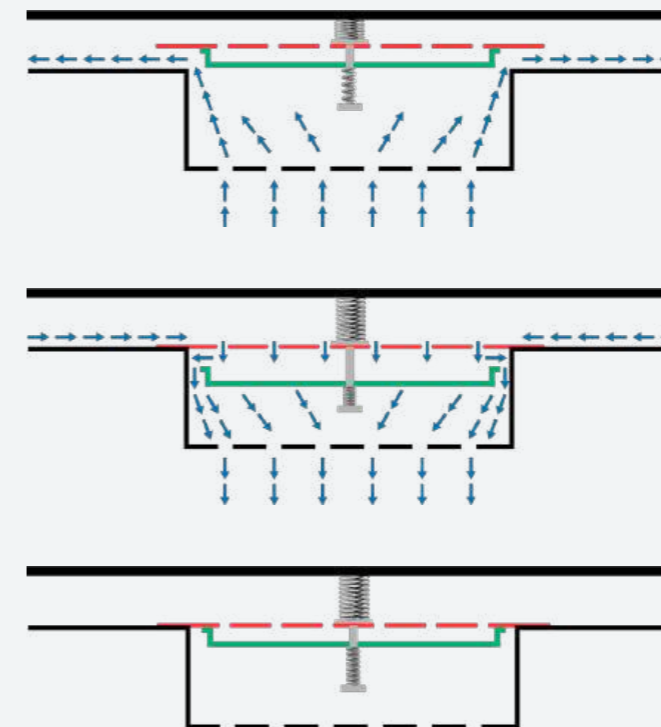

At the beginning of the sterilization cycle, the vacuum phase causes the valves to fully open, allowing the evacuation of dry air from the container.

During the sterilization cycle, the pressure-activated valves automatically open under positive pressure, enabling controlled steam penetration for effective sterilization.

Once the process is complete, and no external forces such as vacuum or pressure are present, the entire system remains sealed, preserving the sterility of its contents.

## Reusable Model

1/1 Full Size

 Different Lids Colors



With Reusable Mechanism



With Color Options



**Non Perforated**

Code	Outside Dimension Inside Dimension L x W x H
K1-10-110	597 x 275 x 95 mm 546 x 258 x 9 mm
K1-10-135	597 x 275 x 120 mm 546 x 258 x 115 mm
K1-10-150	597 x 275 x 136 mm 546 x 258 x 131 mm
K1-10-200	597 x 275 x 188 mm 546 x 258 x 183 mm
K1-10-260	597 x 275 x 235 mm 546 x 258 x 230 mm



**Valve Lids**

Colors	Code
Grey	K2-10-1
Yellow	K2-10-2
Red	K2-10-3
Blue	K2-10-4
Green	K2-10-5
Black	K2-10-6
Purple	K2-10-7
Bronze	K2-10-8

**Dimension**  
585 x 280 x 37 mm



**Barrier Lids**

Colors	Code
Grey	K3-10-1
Yellow	K3-10-2
Red	K3-10-3
Blue	K3-10-4
Green	K3-10-5
Black	K3-10-6
Purple	K3-10-7
Bronze	K3-10-8

**Dimension**  
585 x 280 x 37 mm

### Wire Basket



Mesh: 4x4 mm  
Wire: ø 1 mm

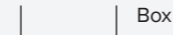

Box



Lid

Code	Outside Dimension L x W x H
B1-5425-30	540 x 245 x 30 mm
B1-5425-50	540 x 245 x 50 mm
B1-5425-70	540 x 245 x 70 mm
B1-5425-100	540 x 245 x 100 mm

**Code**  
B1-5425  
**Outside Dimension**  
L x W x H  
510 x 230 x 5 mm

### Perforated Basket



Mesh: 4x4 mm  
Wire: ø 1 mm

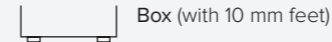

Box (with 10 mm feet)



Lid

Code	Outside Dimension L x W x H
B2-5425-30	540 x 251 x 40 mm
B2-5425-50	540 x 251 x 60 mm
B2-5425-70	540 x 251 x 80 mm
B2-5425-100	540 x 251 x 110 mm

**Code**  
B2-5425  
**Outside Dimension**  
L x W x H  
540 x 256 x 5 mm

### Hybrid Basket



Mesh: 4x4 mm  
Sides: ø 3 mm  
Wire: ø 1 mm

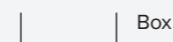

Box



Lid

Code	Outside Dimension L x W x H
B3-5425-50	540 x 255 x 50 mm
B3-5425-70	540 x 255 x 70 mm
B3-5425-100	540 x 255 x 100 mm

**Code**  
B3-5425  
**Outside Dimension**  
L x W x H  
510 x 240 x 5 mm

### Silicone Mat

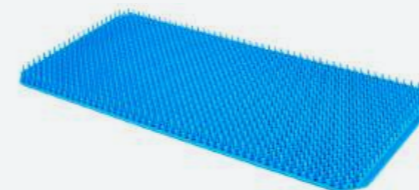

**Code**  
A7-5425  
**Outside Dimension**  
L x W x H  
500 x 235 mm

## Reusable Model

1/1 Full Size Baskets

### Wire Basket



### Perforated Basket

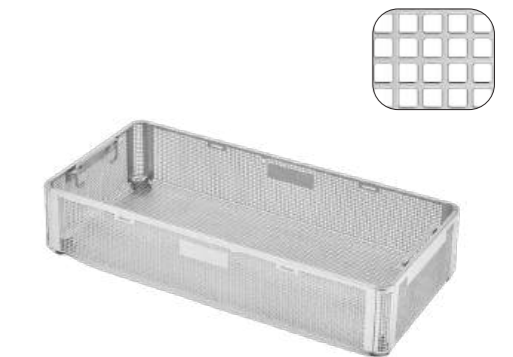

### Hybrid Basket



## Reusable Model

3/4 Quarter Size

 Different Lids Colors



With Reusable Mechanism



With Color Options



Non Perforated

Code	Outside Dimension Inside Dimension L x W x H
K1-20-110	477 x 275 x 95 mm 423 x 258 x 90 mm
K1-20-135	477 x 275 x 120 mm 423 x 258 x 115 mm
K1-20-150	477 x 275 x 136 mm 423 x 258 x 131 mm
K1-20-200	477 x 275 x 188 mm 423 x 258 x 183 mm



Valve Lids

Colors	Code
Grey	K2-20-1
Yellow	K2-20-2
Red	K2-20-3
Blue	K2-20-4
Green	K2-20-5
Black	K2-20-6
Purple	K2-20-7
Bronze	K2-20-8

**Dimension**  
465 x 280 x 37 mm



Barrier Lids

Colors	Code
Grey	K3-20-1
Yellow	K3-20-2
Red	K3-20-3
Blue	K3-20-4
Green	K3-20-5
Black	K3-20-6
Purple	K3-20-7
Bronze	K3-20-8

**Dimension**  
465 x 280 x 37 mm

### Wire Basket



Mesh: 4x4 mm  
Wire: ø 1 mm

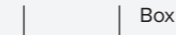

Box



Lid

Code	Outside Dimension L x W x H
B1-4025-30	405 x 245 x 30 mm
B1-4025-50	405 x 245 x 50 mm
B1-4025-70	405 x 245 x 70 mm
B1-4025-100	405 x 245 x 100 mm

**Code**  
B1-4025  
**Outside Dimension  
L x W x H**  
375 x 230 x 5 mm

### Perforated Basket



Mesh: 4x4 mm  
Wire: ø 1 mm

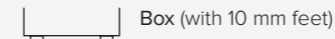

Box (with 10 mm feet)



Lid

Code	Outside Dimension L x W x H
B2-4025-30	403 x 251 x 40 mm
B2-4025-50	403 x 251 x 60 mm
B2-4025-70	403 x 251 x 80 mm
B2-4025-100	403 x 251 x 110 mm

**Code**  
B2-4025  
**Outside Dimension  
L x W x H**  
405 x 256 x 5 mm

### Hybrid Basket



Mesh: 4x4 mm  
Sides: ø 3 mm  
Wire: ø 1 mm

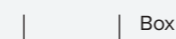

Box



Lid

Code	Outside Dimension L x W x H
B3-4025-50	405 x 255 x 50 mm
B3-4025-70	405 x 255 x 70 mm
B3-4025-100	405 x 255 x 100 mm

**Code**  
B3-4025  
**Outside Dimension  
L x W x H**  
375 x 240 x 5 mm

### Silicone Mat

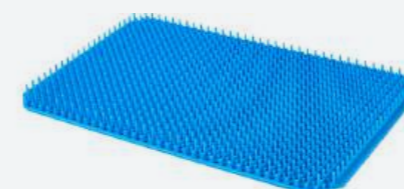

**Code**  
A7-4025  
**Outside Dimension  
L x W x H**  
370 x 235 mm

## Reusable Model

3/4 Quarter Size Baskets

### Wire Basket



### Perforated Basket

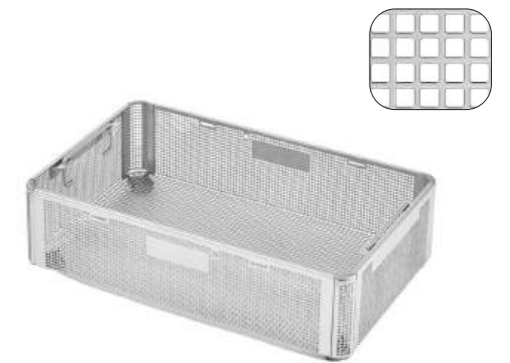

### Hybrid Basket



## Reusable Model

1/2 Half Size

 Different Lids Colors



With Reusable Mechanism



With Color Options



**Non Perforated**

Code	Outside Dimension Inside Dimension L x W x H
K1-30-110	307 x 275 x 95 mm 258 x 258 x 90 mm
K1-30-135	307 x 275 x 120 mm 258 x 258 x 115 mm
K1-30-150	307 x 275 x 136 mm 258 x 258 x 131 mm
K1-30-200	307 x 275 x 188 mm 258 x 258 x 183 mm
K1-30-260	307 x 275 x 235 mm 258 x 258 x 230 mm



**Valve Lids**

Colors	Code
Grey	K2-30-1
Yellow	K2-30-2
Red	K2-30-3
Blue	K2-30-4
Green	K2-30-5
Black	K2-30-6
Purple	K2-30-7
Bronze	K2-30-8

**Dimension**  
295 x 280 x 37 mm



**Barrier Lids**

Colors	Code
Grey	K3-30-1
Yellow	K3-30-2
Red	K3-30-3
Blue	K3-30-4
Green	K3-30-5
Black	K3-30-6
Purple	K3-30-7
Bronze	K3-30-8

**Dimension**  
295 x 280 x 37 mm

### Wire Basket



Mesh: 4x4 mm  
Wire: ø 1 mm

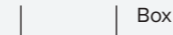

Box



Lid

Code	Outside Dimension L x W x H
B1-2525-30	246 x 246 x 30 mm
B1-2525-50	246 x 246 x 50 mm
B1-2525-70	246 x 246 x 70 mm
B1-2525-100	246 x 246 x 100 mm

**Code**  
B1-2525  
**Outside Dimension**  
L x W x H  
240 x 215 x 5 mm

### Perforated Basket



Mesh: 4x4 mm  
Wire: ø 1 mm

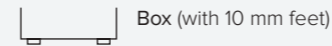

Box (with 10 mm feet)



Lid

Code	Outside Dimension L x W x H
B2-2525-30	244 x 250 x 40 mm
B2-2525-50	244 x 250 x 60 mm
B2-2525-70	244 x 250 x 80 mm
B2-2525-100	244 x 250 x 110 mm

**Code**  
B2-2525  
**Outside Dimension**  
L x W x H  
247 x 256 x 5 mm

### Hybrid Basket



Mesh: 4x4 mm  
Sides: ø 3 mm  
Wire: ø 1 mm



Box



Lid

Code	Outside Dimension L x W x H
B3-2525-50	245 x 255 x 50 mm
B3-2525-70	245 x 255 x 70 mm
B3-2525-100	245 x 255 x 100 mm

**Code**  
B3-2525  
**Outside Dimension**  
L x W x H  
215 x 240 x 5 mm

### Silicone Mat



**Code**  
A7-2525  
**Outside Dimension**  
L x W x H  
225 x 235 mm

## Reusable Model

1/2 Half Size Baskets

### Wire Basket

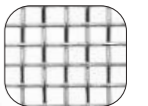
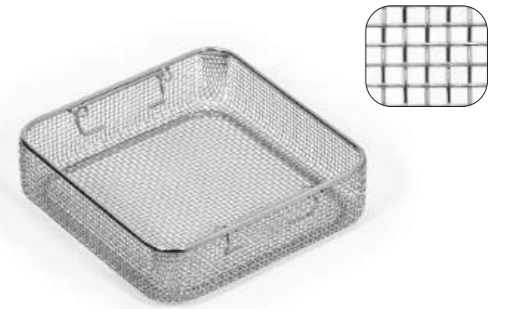

### Perforated Basket

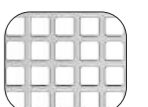
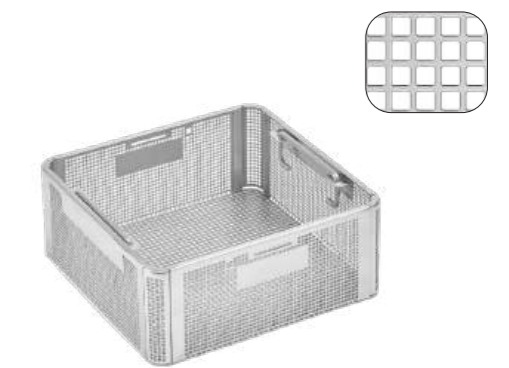

### Hybrid Basket

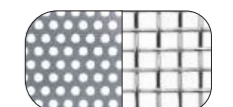

## Reusable Model

Long Size

 Different Lids Colors



With Reusable Mechanism



With Color Options



Code	Outside Dimension Inside Dimension L x W x H
K1-40-150	770 x 275 x 136 mm 715 x 258 x 131 mm
K1-40-200	770 x 275 x 188 mm 715 x 258 x 183 mm



Colors	Code
Grey	K2-40-1
Yellow	K2-40-2
Red	K2-40-3
Blue	K2-40-4
Green	K2-40-5
Black	K2-40-6
Purple	K2-40-7
Bronze	K2-40-8

**Dimension**  
758 x 280 x 37 mm



Colors	Code
Grey	K3-40-1
Yellow	K3-40-2
Red	K3-40-3
Blue	K3-40-4
Green	K3-40-5
Black	K3-40-6
Purple	K3-40-7
Bronze	K3-40-8

**Dimension**  
758 x 280 x 37 mm

### Wire Basket

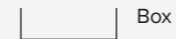

Code	Outside Dimension L x W x H
B1-6625-50	665 x 245 x 50 mm
B1-6625-70	665 x 245 x 70 mm
B1-6625-100	665 x 245 x 100 mm

Mesh: 4x4 mm  
Wire: ø 1 mm



Code	Outside Dimension L x W x H
B1-6625	635 x 230 x 5 mm

### Perforated Basket

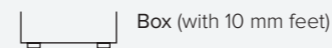

Code	Outside Dimension L x W x H
B2-6625-30	650 x 251 x 40 mm
B2-6625-50	650 x 251 x 60 mm
B2-6625-70	650 x 251 x 80 mm
B2-6625-100	650 x 251 x 110 mm

Mesh: 4x4 mm  
Wire: ø 1 mm



Code	Outside Dimension L x W x H
B2-6625	652 x 256 x 5 mm

### Hybrid Basket

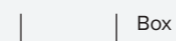

Code	Outside Dimension L x W x H
B3-6625-50	665 x 255 x 50 mm
B3-6625-70	665 x 255 x 70 mm
B3-6625-100	665 x 255 x 100 mm

Mesh: 4x4 mm  
Sides: ø 3 mm  
Wire: ø 1 mm



Code	Outside Dimension L x W x H
B3-6625	635 x 240 x 5 mm

## Reusable Model

Long Size Baskets

### Wire Basket

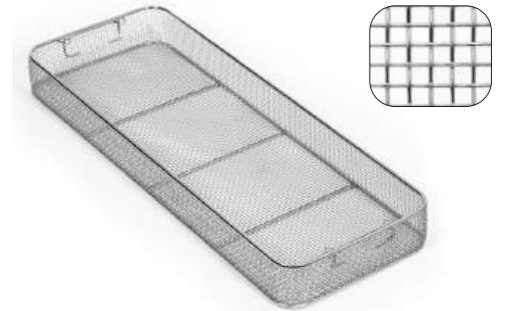

### Perforated Basket

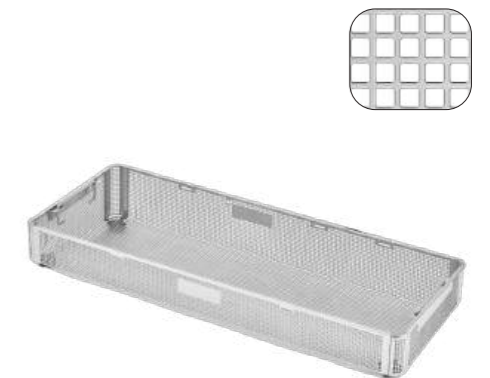

### Hybrid Basket



## Reusable Model

Wide Size

 Different Lids Colors



With Reusable Mechanism



With Color Options

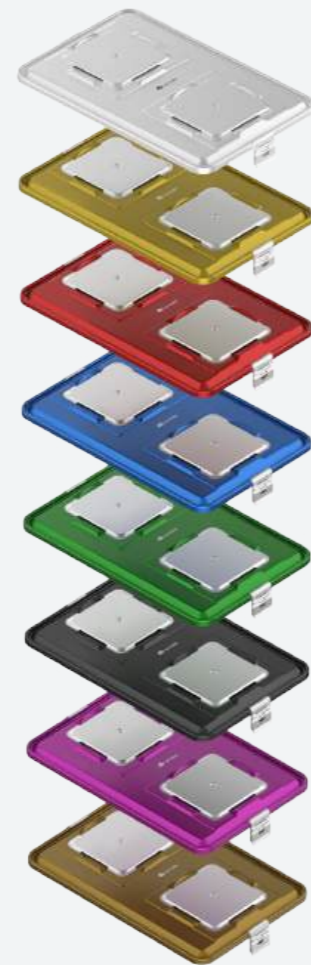

Code	Outside Dimension Inside Dimension L x W x H
K1-50-110	597 x 365 x 105 mm 546 x 348 x 100 mm
K1-50-170	597 x 365 x 165 mm 546 x 348 x 160 mm



Colors	Code
Grey	K2-50-1
Yellow	K2-50-2
Red	K2-50-3
Blue	K2-50-4
Green	K2-50-5
Black	K2-50-6
Purple	K2-50-7
Bronze	K2-50-8

**Dimension**  
585 x 370 x 37mm

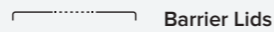

Colors	Code
Grey	K3-50-1
Yellow	K3-50-2
Red	K3-50-3
Blue	K3-50-4
Green	K3-50-5
Black	K3-50-6
Purple	K3-50-7
Bronze	K3-50-8

**Dimension**  
585 x 370 x 37mm

### Wire Basket



Code	Outside Dimension L x W x H
B1-5333-50	533 x 337 x 50 mm
B1-5333-70	533 x 337 x 70 mm
B1-5333-100	533 x 337 x 100 mm

Mesh: 4x4 mm  
Wire: ø 1 mm



Code	Outside Dimension L x W x H
B1-5333	503 x 322 x 5 mm

### Perforated Basket

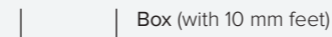

Code	Outside Dimension L x W x H
B2-5333-30	535 x 340 x 40 mm
B2-5333-50	535 x 340 x 60 mm
B2-5333-70	535 x 340 x 80 mm
B2-5333-100	535 x 340 x 110 mm

Mesh: 4x4 mm  
Wire: ø 1 mm



Code	Outside Dimension L x W x H
B2-5333	537 x 343 x 5 mm

### Hybrid Basket

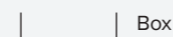

Code	Outside Dimension L x W x H
B3-5333-50	533 x 337 x 50 mm
B3-5333-70	533 x 337 x 70 mm
B3-5333-100	533 x 337 x 100 mm

Mesh: 4x4 mm  
Sides: ø 3 mm  
Wire: ø 1 mm



Code	Outside Dimension L x W x H
B3-5333	503 x 322 x 5 mm

## Reusable Model

Wide Size Baskets

### Wire Basket

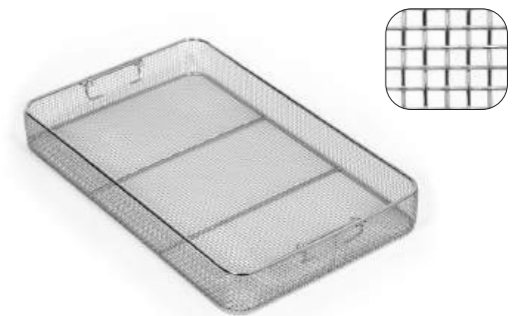

### Perforated Basket



### Hybrid Basket



## Reusable Model

Flat Size

 Different Lids Colors



With Reusable Mechanism



With Color Options



**Code**      **Outside Dimension**  
**Inside Dimension**  
**L x W x H**

K1-90-75	297 x 275 x 75 mm 258 x 258 x 70 mm
----------	--



**Colors**      **Code**

Grey	K3-90-1
Yellow	K3-90-2
Red	K3-90-3
Blue	K3-90-4
Green	K3-90-5
Black	K3-90-6
Purple	K3-90-7
Bronze	K3-90-8

**Dimension**  
 295 x 280 x 37 mm

### Wire Basket



Mesh: 4x4 mm  
 Wire: ø 1 mm



**Code**      **Outside Dimension**  
**L x W x H**

B1-2525-30	246 x 246 x 30 mm
B1-2525-50	246 x 246 x 50 mm



**Code**  
 B1-2525  
**Outside Dimension**  
**L x W x H**  
 240 x 215 x 5 mm

### Perforated Basket



Mesh: 4x4 mm  
 Wire: ø 1 mm

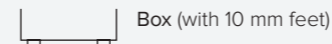

**Code**      **Outside Dimension**  
**L x W x H**

B2-2525-30	244 x 250 x 40 mm
B2-2525-50	244 x 250 x 60 mm



**Code**  
 B2-2525  
**Outside Dimension**  
**L x W x H**  
 247 x 256 x 5 mm

### Silicone Mat



**Code**  
 A7-2525  
**Outside Dimension**  
**L x W x H**  
 225 x 235 mm

## Reusable Model

Flat Size Baskets

### Wire Basket

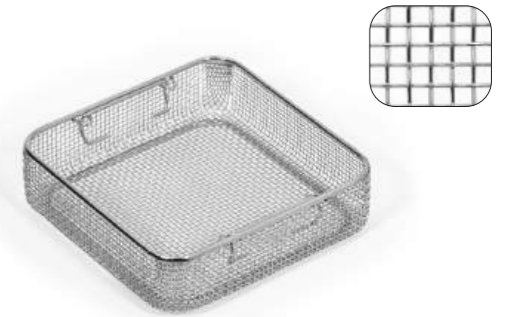

### Perforated Basket

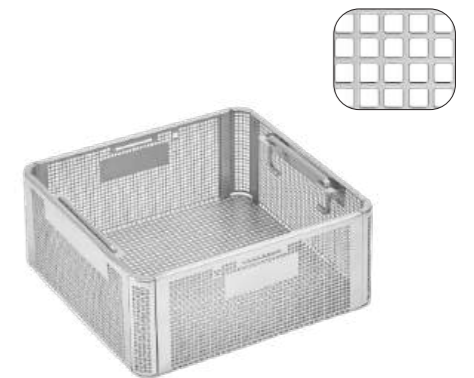

## Reusable Model

Mini Size

 Different Lids Colors



With Reusable Mechanism



With Color Options



**Code**      **Outside Dimension**  
**Inside Dimension**  
**L x W x H**

K1-70-70	305 x 135 x 60 mm 272 x 125 x 48 mm
K1-70-100	305 x 135 x 90 mm 272 x 125 x 78 mm
K1-70-130	305 x 135 x 120 mm 272 x 125 x 108 mm

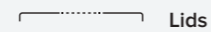

**Colors**    **Code**

Grey	K3-70-1
Yellow	K3-70-2
Red	K3-70-3
Blue	K3-70-4
Green	K3-70-5
Black	K3-70-6
Purple	K3-70-7
Bronze	K3-70-8

**Dimension**  
303 x 136 x 29 mm

### Wire Basket



Mesh: 4x4 mm  
Wire: ø 1 mm



**Code**      **Outside Dimension**  
**L x W x H**

B1-2712-40	268 x 117 x 40 mm
B1-2712-100	268 x 117 x 100 mm



**Code**  
B1-2712  
**Outside Dimension**  
**L x W x H**  
250 x 120 x 5 mm

### Perforated Basket



Mesh: 4x4 mm  
Wire: ø 1 mm

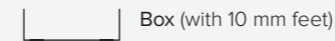

**Code**      **Outside Dimension**  
**L x W x H**

B2-2712-40	260 x 120 x 50 mm
B2-2712-100	260 x 120 x 110 mm



**Code**  
B2-2712  
**Outside Dimension**  
**L x W x H**  
262 x 122 x 5 mm

### Silicone Mat



**Code**  
A7-2712  
**Outside Dimension**  
**L x W x H**  
270 x 125 mm

## Reusable Model

Mini Size Baskets

### Wire Basket



### Perforated Basket

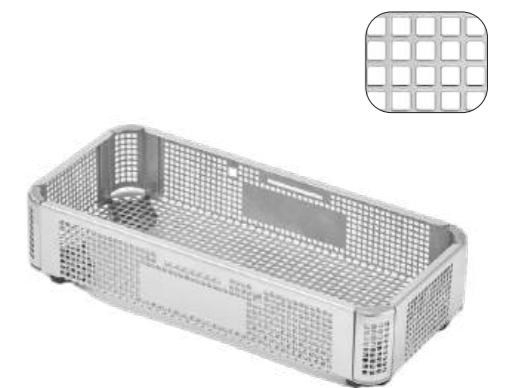

## Reusable Model

Dental Size

 Different Lids Colors



With Reusable Mechanism



With Color Options



**Code**      **Outside Dimension**  
**Inside Dimension**  
**L x W x H**

K1-60-70	310 x 189 x 60 mm 277 x 180 x 48 mm
K1-60-100	310 x 189 x 90 mm 277 x 180 x 78 mm
K1-60-130	310 x 189 x 120 mm 277 x 180 x 108 mm



Colors	Code
Grey	K3-60-1
Yellow	K3-60-2
Red	K3-60-3
Blue	K3-60-4
Green	K3-60-5
Black	K3-60-6
Purple	K3-60-7
Bronze	K3-60-8

**Dimension**  
308 x 190 x 29 mm

### Wire Basket



Mesh: ø 4x4 mm  
Wire: ø 1 mm

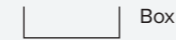

**Code**      **Outside Dimension**  
**L x W x H**

B1-2717-40	270 x 170 x 40 mm
B1-2717-100	270 x 170 x 100 mm



**Code**  
B1-2717  
**Outside Dimension**  
**L x W x H**  
252 x 172 x 5 mm

### Perforated Basket



Mesh: ø 4x4 mm  
Wire: ø 1 mm

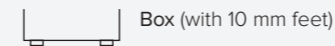

**Code**      **Outside Dimension**  
**L x W x H**

B2-2717-40	273 x 172 x 50 mm
B2-2717-100	273 x 172 x 110 mm



**Code**  
B2-2717  
**Outside Dimension**  
**L x W x H**  
275 x 174 x 5 mm

## Reusable Model

Dental Size Baskets

### Wire Basket

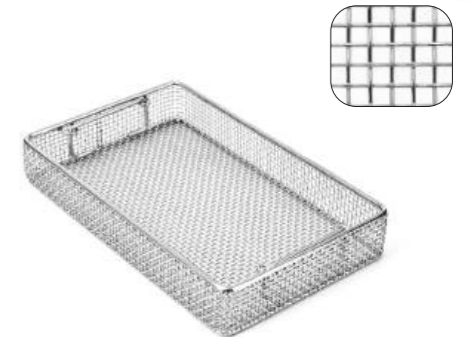

### Perforated Basket



## Reusable Model

1/2 Dental Size

 Different Lids Colors



With Reusable Mechanism



With Color Options



**Code**      **Outside Dimension**  
**Inside Dimension**  
**L x W x H**

K1-80-70	207 x 144 x 60 mm 174 x 135 x 48 mm
K1-80-100	207 x 144 x 90 mm 174 x 135 x 78 mm
K1-80-130	207 x 144 x 120 mm 174 x 135 x 108 mm

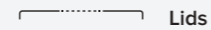

Colors	Code
Grey	K3-80-1
Yellow	K3-80-2
Red	K3-80-3
Blue	K3-80-4
Green	K3-80-5
Black	K3-80-6
Purple	K3-80-7
Bronze	K3-80-8

**Dimension**  
205 x 145 x 29 mm

### Wire Basket



Mesh: ø 4x4 mm  
Wire: ø 1 mm



Code	Outside Dimension L x W x H
B1-1714-40	165 x 130 x 35 mm
B1-1714-100	165 x 130 x 100 mm



**Code**  
B1-1714  
**Outside Dimension**  
**L x W x H**  
147 x 132 x 5 mm

### Perforated Basket



Mesh: ø 4x4 mm  
Wire: ø 1 mm

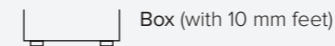

Code	Outside Dimension L x W x H
B2-1714-40	165 x 130 x 50 mm
B2-1714-100	165 x 130 x 110 mm



**Code**  
B2-1714  
**Outside Dimension**  
**L x W x H**  
167 x 130 x 5 mm

## Reusable Model

1/2 Dental Size Baskets

### Wire Basket



### Perforated Basket



Organize.

Sterilize.

Excel.

Holding the  
Standard



Three Different Types of Basket Models by Construction/Material



Perforated Sheet  
Ø 1 mm  
□ 4 mm

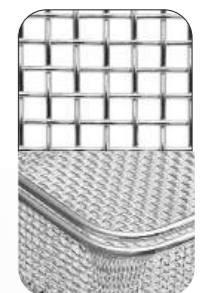

Wire Mesh  
Ø 1 mm  
□ 4 mm



Hybrith  
Ø 1 mm  
□ 4 mm  
Side Mesh  
Ø 3 mm



**Half Size**



Box Code	Outside Dimension L x W x H
B1-2525-30	246 x 246 x 30 mm
B1-2525-50	246 x 246 x 50 mm
B1-2525-70	246 x 246 x 70 mm
B1-2525-100	246 x 246 x 100 mm

Lid Code	Outside Dimension L x W x H
B1-2525	240 x 215 x 5 mm

**Long Size**

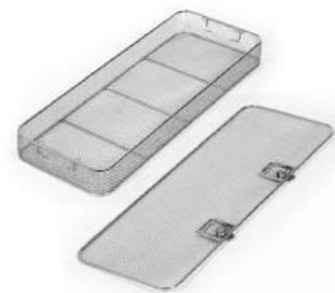

Box Code	Outside Dimension L x W x H
B1-6625-50	665 x 245 x 50 mm
B1-6625-70	665 x 245 x 70 mm
B1-6625-100	665 x 245 x 100 mm
-	-

Lid Code	Outside Dimension L x W x H
B1-6625	635 x 230 x 5 mm

**Wide Size**



Box Code	Outside Dimension L x W x H
B1-5333-50	533 x 337 x 50 mm
B1-5333-70	533 x 337 x 70 mm
B1-5333-100	533 x 337 x 100 mm
-	-

Lid Code	Outside Dimension L x W x H
B1-5333	503 x 322 x 5 mm

**Full Size**



Box Code	Outside Dimension L x W x H
B1-5425-30	540 x 255 x 30 mm
B1-5425-50	540 x 255 x 50 mm
B1-5425-70	540 x 255 x 70 mm
B1-5425-100	540 x 255 x 100 mm

Lid Code	Outside Dimension L x W x H
B1-5425	510 x 230 x 5 mm

**Din Size**



Box Code	Outside Dimension L x W x H
B1-4825-30	480 x 245 x 30 mm
B1-4825-50	480 x 245 x 50 mm
B1-4825-70	480 x 245 x 70 mm
B1-4825-100	480 x 245 x 100 mm

Lid Code	Outside Dimension L x W x H
B1-4825	450 x 230 x 5 mm

**Quarter Size**



Box Code	Outside Dimension L x W x H
B1-4025-30	405 x 245 x 30 mm
B1-4025-50	405 x 245 x 50 mm
B1-4025-70	405 x 245 x 70 mm
B1-4025-100	405 x 245 x 100 mm

Lid Code	Outside Dimension L x W x H
B1-4025	375 x 230 x 5 mm

**Dental Size**

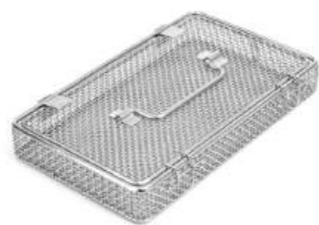

Box Code	Outside Dimension L x W x H
B1-2717-40	270 x 170 x 40 mm
B1-2717-100	270 x 170 x 100 mm
-	-
-	-

Lid Code	Outside Dimension L x W x H
B1-2717	252 x 172 x 5 mm

**Mini Size**



Box Code	Outside Dimension L x W x H
B1-2712-40	268 x 117 x 40 mm
B1-2712-100	268 x 117 x 100 mm
-	-
-	-

Lid Code	Outside Dimension L x W x H
B1-2712	250 x 120 x 5 mm

**Dental 1/2**



Box Code	Outside Dimension L x W x H
B1-1714-40	165 x 130 x 35 mm
B1-1714-100	165 x 130 x 100 mm
-	-
-	-

Lid Code	Outside Dimension L x W x H
B1-1714	147 x 132 x 5 mm

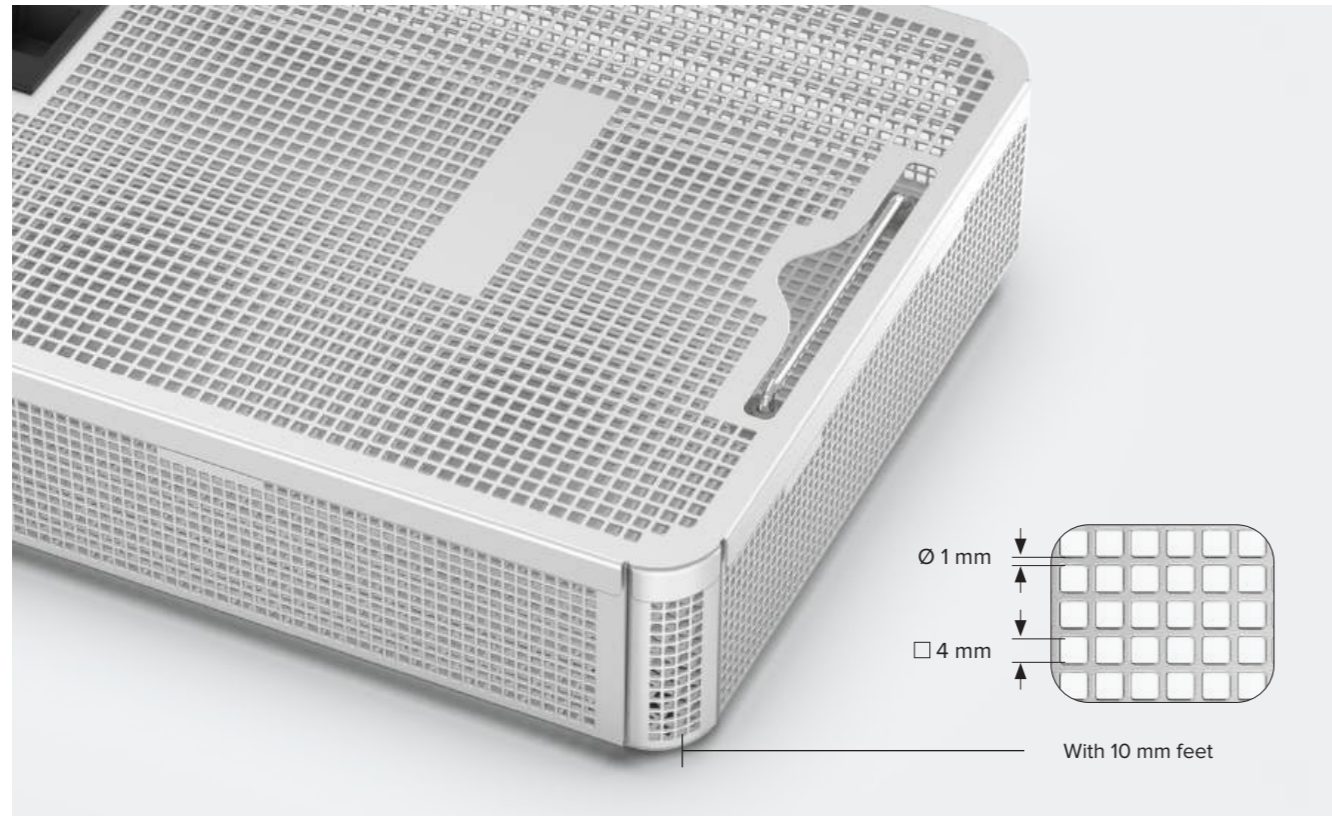

Half Size		Long Size		Wide Size	
<b>Box Code</b>	<b>Outside Dimension L x W x H</b>	<b>Box Code</b>	<b>Outside Dimension L x W x H</b>	<b>Box Code</b>	<b>Outside Dimension L x W x H</b>
B2-2525-30	244 x 250 x 40 mm	B2-6625-30	650 x 251 x 40 mm	B2-5333-30	535 x 340 x 40 mm
B2-2525-50	244 x 250 x 60 mm	B2-6625-50	650 x 251 x 60 mm	B2-5333-50	535 x 340 x 60 mm
B2-2525-70	244 x 250 x 80 mm	B2-6625-70	650 x 251 x 80 mm	B2-5333-70	535 x 340 x 80 mm
B2-2525-100	244 x 250 x 110 mm	B2-6625-100	650 x 251 x 110 mm	B2-5333-100	535 x 340 x 110 mm
<b>Lid Code</b>	<b>Outside Dimension L x W x H</b>	<b>Lid Code</b>	<b>Outside Dimension L x W x H</b>	<b>Lid Code</b>	<b>Outside Dimension L x W x H</b>
B2-2525	247 x 256 x 5 mm	B2-6625	652 x 256 x 5 mm	B2-5333	537 x 343 x 5 mm

Full Size		Din Size		Quarter Size	
<b>Box Code</b>	<b>Outside Dimension L x W x H</b>	<b>Box Code</b>	<b>Outside Dimension L x W x H</b>	<b>Box Code</b>	<b>Outside Dimension L x W x H</b>
B2-5425-30	540 x 251 x 40 mm	B2-4825-30	483 x 251 x 40 mm	B2-4025-30	403 x 251 x 40 mm
B2-5425-50	540 x 251 x 60 mm	B2-4825-50	483 x 251 x 60 mm	B2-4025-50	403 x 251 x 60 mm
B2-5425-70	540 x 251 x 80 mm	B2-4825-70	483 x 251 x 80 mm	B2-4025-70	403 x 251 x 80 mm
B2-5425-100	540 x 251 x 110 mm	B2-4825-100	483 x 251 x 110 mm	B2-4025-100	403 x 251 x 110 mm
<b>Lid Code</b>	<b>Outside Dimension L x W x H</b>	<b>Lid Code</b>	<b>Outside Dimension L x W x H</b>	<b>Lid Code</b>	<b>Outside Dimension L x W x H</b>
B2-5425	540 x 256 x 5 mm	B2-4825	485 x 256 x 5 mm	B2-4025	405 x 256 x 5 mm

Dental Size		Mini Size		Dental 1/2	
<b>Box Code</b>	<b>Outside Dimension L x W x H</b>	<b>Box Code</b>	<b>Outside Dimension L x W x H</b>	<b>Box Code</b>	<b>Outside Dimension L x W x H</b>
B2-2717-40	273 x 172 x 50 mm	B2-2712-40	260 x 120 x 50 mm	B2-1714-40	165 x 130 x 50 mm
B2-2717-100	273 x 172 x 110 mm	B2-2712-100	260 x 120 x 110 mm	B2-1714-100	165 x 130 x 110 mm
-	-	-	-	-	-
-	-	-	-	-	-
<b>Lid Code</b>	<b>Outside Dimension L x W x H</b>	<b>Lid Code</b>	<b>Outside Dimension L x W x H</b>	<b>Lid Code</b>	<b>Outside Dimension L x W x H</b>
B2-2717	275 x 174 x 5 mm	B2-2712	262 x 122 x 5 mm	B2-1714	167 x 130 x 5 mm



Half Size		Long Size		Wide Size	
<b>Box Code</b>	<b>Outside Dimension L x W x H</b>	<b>Box Code</b>	<b>Outside Dimension L x W x H</b>	<b>Box Code</b>	<b>Outside Dimension L x W x H</b>
B3-2525-50	245 x 255 x 50 mm	B3-6625-50	665 x 255 x 50 mm	B3-5333-50	533 x 337 x 50 mm
B3-2525-70	245 x 255 x 70 mm	B3-6625-70	665 x 255 x 70 mm	B3-5333-70	533 x 337 x 70 mm
B3-2525-100	245 x 255 x 100 mm	B3-6625-100	665 x 255 x 100 mm	B3-5333-100	533 x 337 x 100 mm
<b>Lid Code</b>	<b>Outside Dimension L x W x H</b>	<b>Lid Code</b>	<b>Outside Dimension L x W x H</b>	<b>Lid Code</b>	<b>Outside Dimension L x W x H</b>
B3-2525	215 x 240 x 5 mm	B3-6625	635 x 240 x 5 mm	B3-5333	503 x 322 x 5 mm

Fine Mesh Baskets

Full Size		Din Size		Quarter Size	
<b>Box Code</b>	<b>Outside Dimension L x W x H</b>	<b>Box Code</b>	<b>Outside Dimension L x W x H</b>	<b>Box Code</b>	<b>Outside Dimension L x W x H</b>
B3-5425-50	540 x 255 x 50 mm	B3-4825-50	485 x 255 x 50 mm	B3-4025-50	405 x 255 x 50 mm
B3-5425-70	540 x 255 x 70 mm	B3-4825-70	485 x 255 x 70 mm	B3-4025-70	405 x 255 x 70 mm
B3-5425-100	540 x 255 x 100 mm	B3-4825-100	485 x 255 x 100 mm	B3-4025-100	405 x 255 x 100 mm
<b>Lid Code</b>	<b>Outside Dimension L x W x H</b>	<b>Lid Code</b>	<b>Outside Dimension L x W x H</b>	<b>Lid Code</b>	<b>Outside Dimension L x W x H</b>
B3-5425	510 x 240 x 5 mm	B3-4825	455 x 240 x 5 mm	B3-4025	375 x 240 x 5 mm

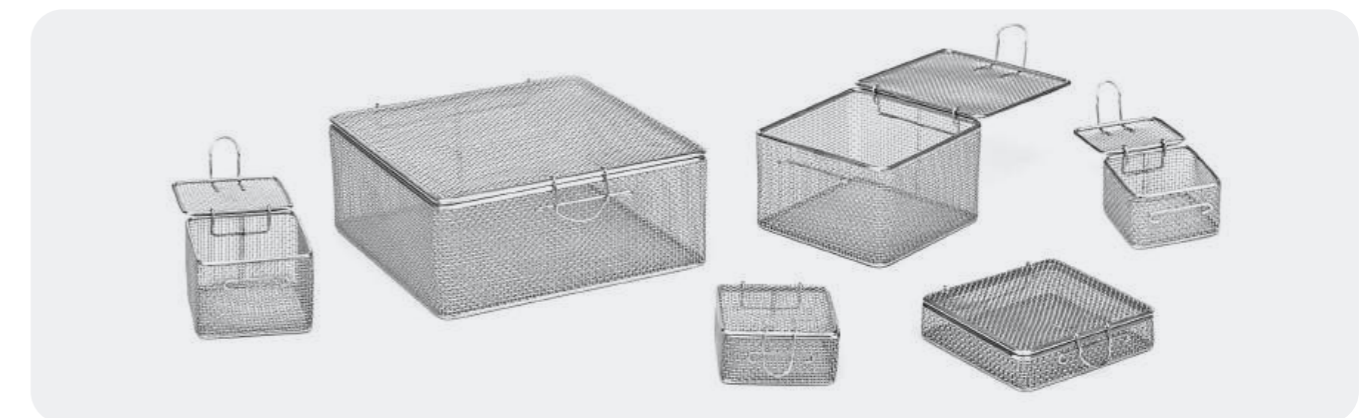

Technical Details		Small Size		Medium Size		Large Size	
Ø 0,5 mm	□ 2 mm	<b>Box Code</b>	<b>Outside Dimension L x W x H</b>	<b>Box Code</b>	<b>Outside Dimension L x W x H</b>	<b>Box Code</b>	<b>Outside Dimension L x W x H</b>
		B4-33-30	30 x 30 x 30 mm	B4-88-40	80 x 80 x 40 mm	B4-88-60	80 x 80 x 60 mm
		B4-44-20	40 x 40 x 20 mm	B4-1212-30	120 x 120 x 30 mm	B4-1212-60	120 x 120 x 60 mm
		B4-66-20	60 x 60 x 20 mm	B4-66-40	60 x 60 x 40 mm	B4-2424-60	240 x 240 x 60 mm
		B4-66-40	60 x 60 x 40 mm				
		B4-84-40	80 x 40 x 40 mm				

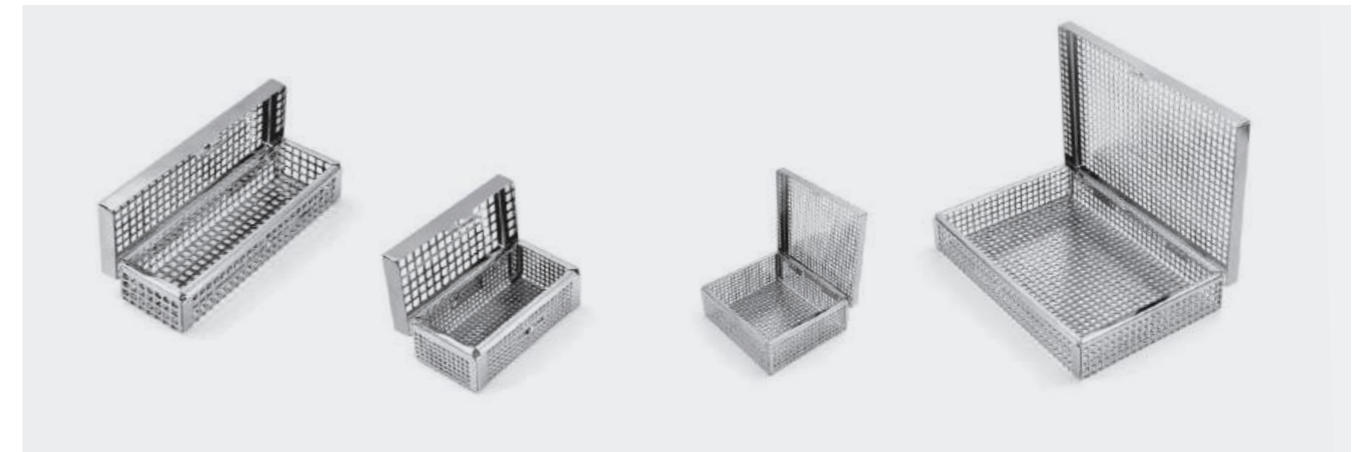

 Bottom With Lid  
W/O Feet  
Wire:  $\phi$  1 mm  
Mesh: 4x4 mm

Code	Dimension L x W x H	Code	Dimension L x W x H
B2-2718-32	275 x 180 x 32 mm	B2-188-32	188 x 86 x 32 mm
B2-2718-42	275 x 180 x 42 mm	B2-144-28	146 x 46 x 28 mm
B2-247-30	240 x 76 x 30 mm	B2-84-28	86 x 46 x 28 mm
B2-1913-34	191 x 130 x 34 mm		

STU - SPRI Baskets

Wire Basket  
Single Scope

**Code**  
B5-298-55-S

**Dimension  
L x W x H**  
290 x 80 x 52 mm

**Code**  
B5-468-55-S

**Dimension  
L x W x H**  
460 x 80 x 52 mm

Wire Basket  
Double Scope

**Code**  
B5-298-55-D

**Dimension  
L x W x H**  
290 x 80 x 52 mm

**Code**  
B5-468-55-D

**Dimension  
L x W x H**  
460 x 80 x 52 mm

Perforated Basket  
Single Scope

**Code**  
B5-278-44-S

**Dimension  
L x W x H**  
272 x 83 x 44 mm

**Code**  
B5-458-44-S

**Dimension  
L x W x H**  
452 x 83 x 44 mm

Perforated Basket  
Double Scope

**Code**  
B5-2710-44-D

**Dimension  
L x W x H**  
272 x 103 x 44 mm

**Code**  
B5-4510-44-D

**Dimension  
L x W x H**  
452 x 103 x 44 mm

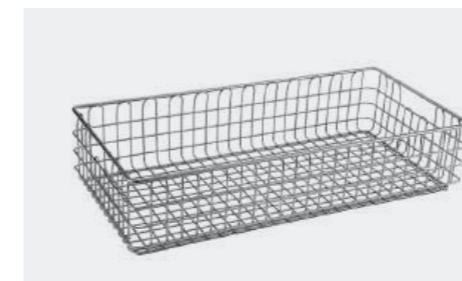

STU Baskets

Box Code	Outside Dimension L x W x H	Details
B7-5728-135	575 x 280 x 135 mm	Upper Frame: $\phi$ 6 mm
B7-5728-265	575 x 280 x 265 mm	Body Wires: $\phi$ 2 & 3 mm Base Frame $\phi$ 5 mm

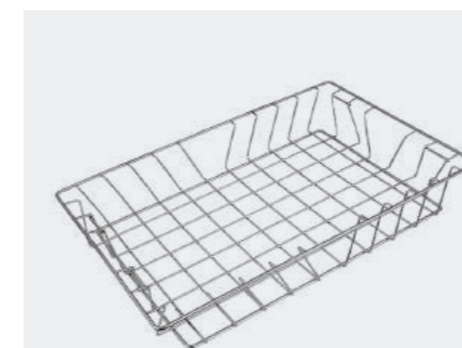

SPRI Baskets

Box Code	Outside Dimension L x W x H	Details
B8-6030-40	600x300x40 mm	Main Frame: $\phi$ 6 mm
B8-6030-100	600x300x100 mm	Body Wire: $\phi$ 4 mm
B8-6030-150	600x300x150 mm	Base Frame $\phi$ 5 mm
B8-6040-100	600x400x100 mm	Single Frame Stackable
B8-6040-150	600x400x150 mm	
B8-6040-200	600x400x200 mm	



Paper Filters		PTFE Teflon Filters									
<b>Code</b> A1-10-1 <b>For:</b> 1/1, 3/4, 1/2, Long, Wide <b>Size:</b> Ø 185 mm	<b>Code</b> A1-11-1 <b>For:</b> Small Size Containers <b>Size:</b> Ø 88 mm	<b>Code</b> A1-20-1 <b>For:</b> 1/1, 3/4, 1/2, Long, Wide <b>Size:</b> Ø 190 mm <b>Cycle:</b> 2000 Cycles Reusable	<b>Code</b> A1-21-1 <b>For:</b> Small Size Containers <b>Size:</b> Ø 88 mm <b>Cycle:</b> 2000 Cycles Reusable								
<b>Code</b> A1-20-2 <b>For:</b> 1/1, 3/4, 1/2, Long, Wide <b>Size:</b> Ø 190 mm <b>Cycle:</b> 1200 Cycles Reusable	<b>Code</b> A1-21-2 <b>For:</b> Small Size Containers <b>Size:</b> Ø 88 mm <b>Cycle:</b> 1200 Cycles Reusable	<table border="1"> <tr> <td><b>Material</b></td> <td>73g/m<sup>2</sup> Medical Grade Paper</td> </tr> <tr> <td><b>Package</b></td> <td>100 pcs</td> </tr> <tr> <td><b>Sterilization</b></td> <td>Steam</td> </tr> <tr> <td><b>Cycle</b></td> <td>Single Use</td> </tr> </table>		<b>Material</b>	73g/m <sup>2</sup> Medical Grade Paper	<b>Package</b>	100 pcs	<b>Sterilization</b>	Steam	<b>Cycle</b>	Single Use
<b>Material</b>	73g/m <sup>2</sup> Medical Grade Paper										
<b>Package</b>	100 pcs										
<b>Sterilization</b>	Steam										
<b>Cycle</b>	Single Use										

Polymer Security Seals		Polymer Security Seals With Indicator	
<b>Code</b> A2-10-1 <b>Package</b> 100 pcs <b>Sterilization</b> Steam <b>Cycle</b> Single Use <b>Color</b> Blue	<b>Code</b> A2-20-1 <b>Package</b> 100 pcs <b>Sterilization</b> Steam <b>Cycle</b> Single Use <b>Color</b> Red	<b>Code</b> A2-10-2 <b>Package</b> 100 pcs <b>Sterilization</b> Steam <b>Cycle</b> Single Use <b>Color</b> Blue	<b>Code</b> A2-20-2 <b>Package</b> 100 pcs <b>Sterilization</b> Steam <b>Cycle</b> Single Use <b>Color</b> Red



Identification Labels				Filter Retainers																									
<b>Color</b> Grey <b>Code</b> A5-10-1	<b>Color</b> Yellow <b>Code</b> A5-10-2	<b>Color</b> Red <b>Code</b> A5-10-3	<b>Color</b> Blue <b>Code</b> A5-10-4	<b>Code</b> A6-10-1 <b>For:</b> 1/1, 3/4, 1/2, Long, Wide	<b>Code</b> A6-10-2 <b>For:</b> Small Size Containers																								
				<table border="1"> <tr> <td><b>Material</b></td> <td>1,5 mm Aluminum</td> </tr> <tr> <td><b>Package</b></td> <td>1 Piece</td> </tr> <tr> <td><b>Sterilization</b></td> <td>Steam</td> </tr> <tr> <td><b>Marking</b></td> <td>Maximum 24 Letters</td> </tr> </table>		<b>Material</b>	1,5 mm Aluminum	<b>Package</b>	1 Piece	<b>Sterilization</b>	Steam	<b>Marking</b>	Maximum 24 Letters																
<b>Material</b>	1,5 mm Aluminum																												
<b>Package</b>	1 Piece																												
<b>Sterilization</b>	Steam																												
<b>Marking</b>	Maximum 24 Letters																												
<table border="1"> <thead> <tr> <th colspan="2">Paper Labels</th> <th colspan="2"></th> </tr> </thead> <tbody> <tr> <td></td> <td></td> <td><b>Material</b></td> <td>Paper</td> </tr> <tr> <td><b>Code</b> A3-10-1 with indicator</td> <td><b>Code</b> A3-10-2 with indicator</td> <td><b>Size</b></td> <td>Big &amp; Small</td> </tr> <tr> <td colspan="2"></td> <td><b>Package</b></td> <td>100 pcs</td> </tr> <tr> <td colspan="2"></td> <td><b>Sterilization</b></td> <td>Steam</td> </tr> </tbody> </table>				Paper Labels						<b>Material</b>	Paper	<b>Code</b> A3-10-1 with indicator	<b>Code</b> A3-10-2 with indicator	<b>Size</b>	Big & Small			<b>Package</b>	100 pcs			<b>Sterilization</b>	Steam	<table border="1"> <tr> <td><b>Material</b></td> <td>Stainless Steel</td> </tr> <tr> <td><b>Package</b></td> <td>1 piece</td> </tr> </table>		<b>Material</b>	Stainless Steel	<b>Package</b>	1 piece
Paper Labels																													
		<b>Material</b>	Paper																										
<b>Code</b> A3-10-1 with indicator	<b>Code</b> A3-10-2 with indicator	<b>Size</b>	Big & Small																										
		<b>Package</b>	100 pcs																										
		<b>Sterilization</b>	Steam																										
<b>Material</b>	Stainless Steel																												
<b>Package</b>	1 piece																												

Silicone Mats & Nets											
	<b>Code</b> A7-5425 <b>Size</b> 500 X 235 mm		<b>Code</b> A4-5425 <b>Size</b> 520 x 242 mm								
	<b>Code</b> A7-4025 <b>Size</b> 370 X 235 mm		<b>Code</b> A4-4025 <b>Size</b> 380 x 242 mm								
	<b>Code</b> A7-2525 <b>Size</b> 225 x 235 mm		<b>Code</b> A4-2525 <b>Size</b> 255 x 250 mm								
	<b>Code</b> A7-2712 <b>Size</b> 270 x 125 mm	<table border="1"> <tr> <td><b>Material</b></td> <td>Medical Grade Silicone</td> </tr> <tr> <td><b>Package</b></td> <td>1 Piece</td> </tr> <tr> <td><b>Sterilization</b></td> <td>Steam</td> </tr> <tr> <td><b>Color</b></td> <td>Light Blue</td> </tr> </table>		<b>Material</b>	Medical Grade Silicone	<b>Package</b>	1 Piece	<b>Sterilization</b>	Steam	<b>Color</b>	Light Blue
<b>Material</b>	Medical Grade Silicone										
<b>Package</b>	1 Piece										
<b>Sterilization</b>	Steam										
<b>Color</b>	Light Blue										
<table border="1"> <tr> <td></td> <td><b>h:</b> 14 mm</td> <td rowspan="3"><b>h:</b> 16 mm</td> </tr> <tr> <td></td> <td><b>h:</b> 5 mm</td> </tr> <tr> <td></td> <td><b>h:</b> 2 mm</td> </tr> </table>					<b>h:</b> 14 mm	<b>h:</b> 16 mm		<b>h:</b> 5 mm		<b>h:</b> 2 mm	
	<b>h:</b> 14 mm	<b>h:</b> 16 mm									
	<b>h:</b> 5 mm										
	<b>h:</b> 2 mm										

Silicone Gasket					
	<b>Code</b> A11-10-1 <b>Size</b> 1/1 Full	<b>Code</b> A11-40-1 <b>Size</b> Long	<b>Code</b> A11-70-1 <b>Size</b> Mini	<b>Material</b>	Medical Grade Sealing Silicone
	<b>Code</b> A11-20-1 <b>Size</b> 3/4 Quarter	<b>Code</b> A11-50-1 <b>Size</b> Wide	<b>Code</b> A11-80-1 <b>Size</b> 1/2 Dental	<b>Package</b>	1 Piece
	<b>Code</b> A11-30-1 <b>Size</b> 1/2 Half	<b>Code</b> A11-60-1 <b>Size</b> Dental	<b>Code</b> A11-90-1 <b>Size</b> Flat	<b>Shape</b>	D shape, Jointless
				<b>Feature</b>	Place & Go, No Glue Required



**Code T1-10-1**  
 Material : Stainless Steel  
 Feet : 4 wheels - 2 braked  
 Package : 1 Piece  
 Dimensions: 600 x 860 x 900 mm (W x L x H)



**Code T1-10-2**  
 Material : Stainless Steel  
 Feet : 4 wheels - 2 braked  
 Package : 1 Piece  
 Dimensions: 550 x 860 x 900 mm (W x L x H)



**Code T1-10-5**  
 Material : Stainless Steel  
 Feet : 4 Adjustable Leveling Feet  
 Package : 1 Piece  
 Dimensions: 600 x 1400 x 850 mm (W x L x H)



**Code T1-10-6**  
 Material : Stainless Steel  
 Feet : 4 wheels - 2 braked  
 Package : 1 Piece  
 Dimensions: 700 x 360 x 1350 mm (W x L x H)



**Code T1-10-3**  
 Material : Stainless Steel  
 Feet : 4 wheels - 2 braked  
 Package : 1 Piece  
 Dimensions: 600 x 850 x 900 mm (W x L x H)



**Code T1-10-4**  
 Material : Stainless Steel  
 Feet : 4 wheels - 2 braked  
 Package : 1 Piece  
 Dimensions: 550 x 860 x 900 mm (W x L x H)

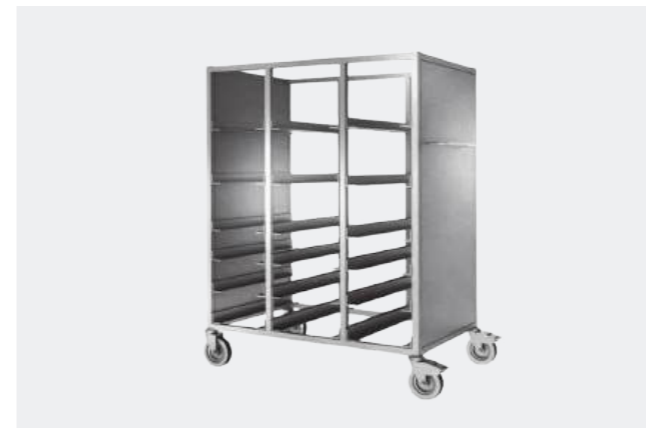

**Code T1-10-7**  
 Material : Stainless Steel  
 Feet : 4 wheels - 2 braked  
 Package : 1 Piece  
 Dimensions: 700 x 1080 x 1350 mm (W x L x H)



**Code T1-10-8**  
 Material : Stainless Steel  
 Feet : 4 wheels - 2 braked  
 Package : 1 Piece - including 3 baskets  
 Dimensions: 400 x 600 x 1700 (W x L x H)

Code	Page	Code	Page	Code	Page	Code	Page
A1-10-1	68	B1-6625-100	25, 47, 61	B3-5425-50	19, 41, 65	K1-30-6	22
A11-10-1	69	B1-6625-50	25, 47, 61	B3-5425-70	19, 41, 65	K1-30-7	22
A1-11-1	68	B1-6625-70	25, 47, 61	B3-6625	25, 47, 65	K1-30-8	22
A11-20-1	69	B2-144-28	67	B3-6625-100	25, 47, 65	K1-40-1	24
A11-30-1	69	B2-1714	35, 57, 63	B3-6625-50	25, 47, 65	K1-40-150	24, 46
A11-40-1	69	B2-1714-100	35, 57, 63	B3-6625-70	25, 47, 65	K1-40-2	24
A11-50-1	69	B2-1714-40	35, 57, 63	B4-1212-30	65	K1-40-200	24, 46
A11-60-1	69	B2-188-32	67	B4-1212-60	65	K1-40-3	24
A11-70-1	69	B2-1913-34	67	B4-2424-60	65	K1-40-4	24
A11-80-1	69	B2-247-30	67	B4-33-30	65	K1-40-5	24
A11-90-1	69	B2-2525	23, 29, 45, 51, 61	B4-44-20	65	K1-40-6	24
A1-20-1	68	B2-2525-100	23, 45, 61	B4-66-20	65	K1-40-7	24
A1-21-1	68	B2-2525-30	23, 29, 45, 51, 61	B4-66-40	65	K1-40-8	24
A2-10-1	68	B2-2525-50	23, 29, 45, 51, 61	B4-84-40	65	K1-50-1	26
A2-10-2	68	B2-2525-70	23, 45, 61	B4-88-40	65	K1-50-110	26, 48
A2-20-1	68	B2-2712	31,53,63	B4-88-60	65	K1-50-170	26, 48
A2-20-2	68	B2-2712-100	31,53,63	B5-2710-44-D	66	K1-50-2	26
A3-10-1	69	B2-2712-40	31,53,63	B5-278-44-S	66	K1-50-3	26
A3-10-2	69	B2-2717	35, 57, 63	B5-298-55-D	66	K1-50-4	26
A5-10-1	69	B2-2717-100	35, 57, 63	B5-298-55-S	66	K1-50-5	26
A5-10-2	69	B2-2717-40	35, 57, 63	B5-4510-44-D	66	K1-50-6	26
A5-10-3	69	B2-2718-32	67	B5-458-44-S	66	K1-50-7	26
A5-10-4	69	B2-2718-42	67	B5-468-55-S	66	K1-50-8	26
A5-10-5	69	B2-4025	21, 43, 62	B5-468-55-D	66	K1-60-1	32
A5-10-6	69	B2-4025-100	21, 43, 62	B7-5728-135	67	K1-60-100	32, 54
A5-10-7	69	B2-4025-30	21, 43, 62	B7-5728-265	67	K1-60-130	32, 54
A5-10-8	69	B2-4025-50	21, 43, 62	B8-6030-100	67	K1-60-2	32
A6-10-1	69	B2-4025-70	21, 43, 62	B8-6030-150	67	K1-60-3	32
A6-10-2	69	B2-4825	62	B8-6030-40	67	K1-60-4	32
A7-2525	22, 29, 45, 51, 69	B2-4825-100	62	B8-6040-100	67	K1-60-40	32
A7-2712	31, 53, 69	B2-4825-30	62	B8-6040-150	67	K1-60-5	32
A7-4025	21, 43, 69	B2-4825-50	62	B8-6040-200	67	K1-60-6	32
A7-5425	19, 41, 69	B2-4825-70	62	K1-10-1	18	K1-60-7	32
B1-1714	35, 57, 63	B2-5333	27, 49, 63	K1-10-110	18, 40	K1-60-70	32, 55
B1-1714-100	35, 57, 63	B2-5333-100	27, 49, 63	K1-10-135	18, 40	K1-60-8	32
B1-1714-40	35, 57, 63	B2-5333-30	27, 49, 63	K1-10-150	18, 40	K1-70-1	32
B1-2525	23, 29, 45, 51, 61, 65	B2-5333-50	27, 49, 63	K1-10-2	18	K1-70-100	32, 55
B1-2525-100	23, 45, 61	B2-5333-70	27, 49, 63	K1-10-200	18, 40	K1-70-130	32, 55
B1-2525-30	23, 29, 45, 51, 61	B2-5425	19,41, 62	K1-10-260	18, 40	K1-70-2	32
B1-2525-50	23, 29, 45, 51, 61	B2-5425-100	19,41, 62	K1-10-3	18	K1-70-3	32
B1-2525-70	23, 45, 61	B2-5425-30	19,41, 62	K1-10-4	18	K1-70-4	32
B1-2712	31, 53, 61	B2-5425-50	19,41, 62	K1-10-5	18	K1-70-40	32
B1-2712-100	31, 53, 61	B2-5425-70	19,41, 62	K1-10-6	18	K1-70-5	32, 32
B1-2712-40	31, 53, 61	B2-6625	25, 47, 63	K1-10-7	18	K1-70-6	32
B1-2717	33, 55, 61	B2-6625-100	25, 47, 63	K1-10-8	18	K1-70-7	32
B1-2717-100	33, 55, 61	B2-6625-30	25, 47, 63	K1-20-1	20	K1-70-70	32, 55
B1-2717-40	33, 55, 61	B2-6625-50	25, 47, 63	K1-20-110	20, 42	K1-70-8	32
B1-4025	21, 43, 60, 64	B2-6625-70	25, 47, 63	K1-20-135	20, 42	K1-80-1	34
B1-4025-100	21, 43, 60	B2-84-28	67	K1-20-150	20, 42	K1-80-100	34, 56
B1-4025-30	21, 43, 60	B3-2525	23, 45, 65	K1-20-2	20	K1-80-130	34, 56
B1-4025-50	21, 43, 60	B3-2525-100	23, 45, 65	K1-20-200	20, 42	K1-80-2	34
B1-4025-70	21, 43, 60	B3-2525-50	23, 45, 65	K1-20-3	20	K1-80-3	34
B1-4825	60, 64	B3-2525-70	23, 45, 65	K1-20-4	20	K1-80-4	34
B1-4825-100	60	B3-4025	21, 45, 65	K1-20-5	20	K1-80-40	34
B1-4825-30	60	B3-4025-100	21, 43, 65	K1-20-6	20	K1-80-5	34
B1-4825-50	60	B3-4025-50	21, 43, 65	K1-20-7	20	K1-80-6	34
B1-4825-70	60	B3-4025-70	21, 43, 65	K1-20-8	20	K1-80-7	34
B1-5333	27, 49, 61	B3-4825	67	K1-30-1	22	K1-80-70	34, 56
B1-5333-100	27, 49, 61	B3-4825-100	67	K1-30-110	22, 44	K1-80-8	34
B1-5333-50	27, 49, 61	B3-4825-50	67	K1-30-135	22, 44	K1-90-1	28
B1-5333-70	27, 49, 61	B3-4825-70	67	K1-30-150	22, 44	K1-90-2	28
B1-5425	19, 41, 60, 64	B3-5333	27, 49, 65	K1-30-2	22	K1-90-3	28
B1-5425-100	19,41, 60	B3-5333-100	27, 49, 65	K1-30-200	22, 44	K1-90-4	28
B1-5425-30	19,41, 60	B3-5333-50	27, 49, 65	K1-30-260	22, 44	K1-90-45	28
B1-5425-50	19,41, 60	B3-5333-70	27, 49, 65	K1-30-3	22	K1-90-5	28
B1-5425-70	19,41, 60	B3-5425	19, 41, 65	K1-30-4	22	K1-90-6	28
B1-6625	25, 47, 61, 65	B3-5425-100	19, 41, 65	K1-30-5	22	K1-90-7	28

Code	Page	Code	Page	Code	Page
K1-90-75	28, 50	K3-40-2	46	KS1-10-3	18
K1-90-8	28	K3-40-3	46	KS1-10-4	18
K2-10-1	40	K3-40-4	46	KS1-10-5	18
K2-10-2	40	K3-40-5	46	KS1-10-6	18
K2-10-3	40	K3-40-6	46	KS1-10-7	18
K2-10-4	40	K3-40-7	46	KS1-10-8	18
K2-10-5	40	K3-40-8	46	KS1-20-1	20
K2-10-6	40	K3-50-1	48	KS1-20-2	20
K2-10-7	40	K3-50-2	48	KS1-20-3	20
K2-10-8	40	K3-50-3	48	KS1-20-4	20
K2-20-1	42	K3-50-4	48	KS1-20-5	20
K2-20-2	42	K3-50-5	48	KS1-20-6	20
K2-20-3	42	K3-50-6	48	KS1-20-7	20
K2-20-4	42	K3-50-7	48	KS1-20-8	20
K2-20-5	42	K3-50-8	48	KS1-30-1	22
K2-20-6	42	K3-60-1	54	KS1-30-2	22
K2-20-7	42	K3-60-2	54	KS1-30-3	22
K2-20-8	42	K3-60-3	54	KS1-30-4	22
K2-30-1	44	K3-60-4	54	KS1-30-5	22
K2-30-2	44	K3-60-5	54	KS1-30-6	22
K2-30-3	44	K3-60-6	54	KS1-30-7	22
K2-30-4	44	K3-60-7	54	KS1-30-8	22
K2-30-5	44	K3-60-8	54	T1-10-1	70
K2-30-6	44	K3-70-1	52	T1-10-2	70
K2-30-7	44	K3-70-2	52	T1-10-3	70
K2-30-8	44	K3-70-3	52	T1-10-4	70
K2-40-1	46	K3-70-4	52	T1-10-5	71
K2-40-2	46	K3-70-5	52	T1-10-6	71
K2-40-3	46	K3-70-6	52	T1-10-7	71
K2-40-4	46	K3-70-7	52	T1-10-8	71
K2-40-5	46	K3-70-8	52		
K2-40-6	46	K3-80-1	56		
K2-40-7	46	K3-80-2	56		
K2-40-8	46	K3-80-3	56		
K2-50-1	48	K3-80-4	56		
K2-50-2	48	K3-80-5	56		
K2-50-3	48	K3-80-6	56		
K2-50-4	48	K3-80-7	56		
K2-50-5	48	K3-80-8	56		
K2-50-6	48	K3-90-1	50		
K2-50-7	48	K3-90-2	50		
K2-50-8	48	K3-90-3	50		
K3-10-1	40	K3-90-4	50		
K3-10-2	40	K3-90-5	50		
K3-10-3	40	K3-90-6	50		
K3-10-4	40	K3-90-7	50		
K3-10-5	40	K3-90-8	50		
K3-10-6	40	KP1-10-110	18		
K3-10-7	40	KP1-10-135	18		
K3-10-8	40	KP1-10-150	18		
K3-20-1	42	KP1-10-200	18		
K3-20-2	42	KP1-10-260	18		
K3-20-3	42	KP1-20-110	20		
K3-20-4	42	KP1-20-135	20		
K3-20-5	42	KP1-20-150	20		
K3-20-6	42	KP1-20-200	20		
K3-20-7	42	KP1-30-110	22		
K3-20-8	42	KP1-30-135	22		
K3-30-1	44	KP1-30-150	22		
K3-30-2	44	KP1-30-200	22		
K3-30-3	44	KP1-30-260	22		
K3-30-4	44	KP1-40-150	24		
K3-30-5	44	KP1-40-200	24		
K3-30-6	44	KP1-50-110	26		
K3-30-7	44	KP1-50-170	26		
K3-30-8	44	KS1-10-1	18		
K3-40-1	46	KS1-10-2	18		





İstiklal Mah. 58. Sokak  
No: 61 PK: 55310  
Tekkeköy/Samsun/Türkiye

+90 362 363 00 01  
victorishealth.com  
info@victorishealth.com

Secure Today  
Elevate Tomorrow



All rights reserved. No part of this catalog may be reproduced, copied,  
or published in any form without the written permission of