

Sterilization Container Systems

Secure Today
Elevate Tomorrow





Victoris retains the right to modify and enhance the products showcased in this catalogue as part of ongoing development efforts. All provided weight and dimensional information are approximate and may vary from the actual products.

Copyright © Victoris Co., Inc. All Rights Reserved
VH-CC-K001 Rev.03

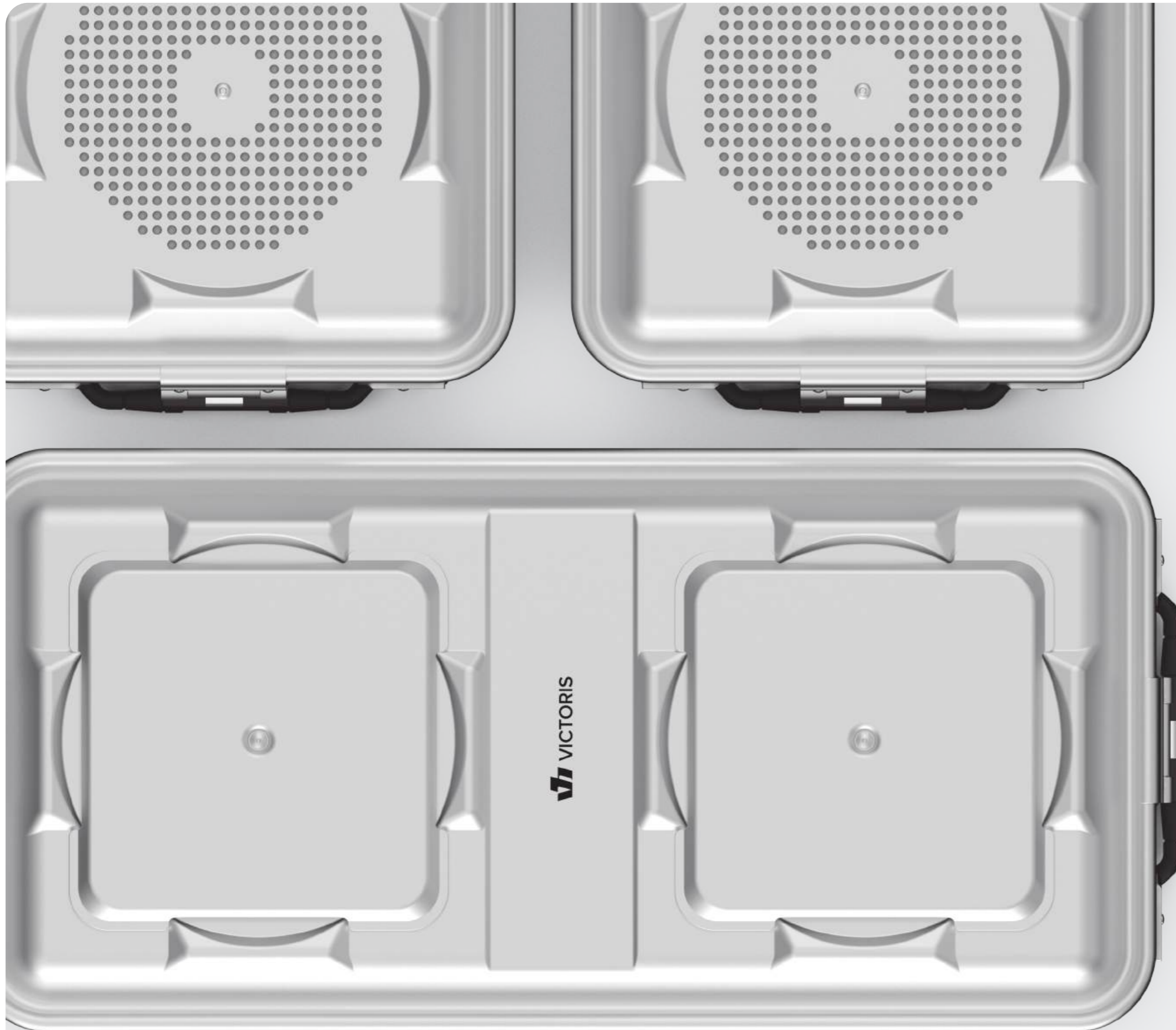

Table Of Contents

06	INTRODUCTION	→	15
16	STANDARD MODELS	→	35
36	REUSABLE MODELS	→	57
58	STERILIZATION BASKETS	→	67
68	ACCESSORIES & COMPONENTS	→	69
70	TROLLEYS & TABLES	→	71
72	INDEX	→	73

The Full Story

Victoris is more than a healthcare supply company; it's a testament to resilience, integrity, and a commitment to human values. Founded by two industry professionals who shared a vision for a workplace that prioritizes people over profit, our story began in the halls of an international medical device company. In the face of adversity, to create a company that not only thrives in the industry but serves as a beacon of compassion and ethical leadership. Victoris was born from the belief that success is measured not just in financial gains but in the positive impact a company can have on its employees and the community it serves.



Our Vision

At Victoris, our vision is to be a leader in healthcare solutions, recognized not only for the quality of our products but for the unwavering commitment to the well-being of our employees and the communities we serve. We envision a future where healthcare is not only about cutting-edge technology but also about compassionate and ethical practices, setting a benchmark for the industry.

Our Mission

Our mission at Victoris is twofold. Firstly, to provide exceptional healthcare products that enhance the lives of individuals undergoing medical procedures, for humans or pets. Secondly, to pioneer a corporate culture that prioritizes the welfare of our team members, recognizing them as the driving force behind our success. We are dedicated to fostering an environment that values diversity, upholds human rights, and serves as a beacon for responsible and ethical business practices.

Precision in Form, Compliance in Function

R&D

Experience the innovation driving Victoris with our dedicated Research and Development (R&D) division. Our R&D team is committed to pushing the boundaries of healthcare technology, continually developing breakthrough solutions to meet the evolving needs of the industry.

Utilizing cutting-edge technologies and advanced methodologies, our focus on rigorous testing and constant improvement ensures that each product meets the highest standards of quality and reliability. Trust in our relentless pursuit of excellence to elevate your operations and achieve unparalleled performance.

Production

Discover the excellence of Victoris production processes, designed to ensure precision, efficiency, and unparalleled quality. Our advanced production techniques are meticulously developed to deliver consistent results, ensuring that every product meets the highest standards of safety and reliability.

Spanning a closed production area of 2000 square meters, we leverage innovative technologies and streamlined workflows to minimize downtime and enhance productivity. Trust in our expertise to maintain the utmost quality and reliability in every aspect of your operations.

Regulatory / Quality

At Victoris, our unwavering commitment to quality, safety, and compliance, including adherence to regulatory bodies such as CE, FDA, and ISO, is the driving force behind everything we do. Our Regulatory Affairs and Quality Assurance department, at the heart of our operations, ensures that our products consistently meet the highest industry standards and comply with all relevant guidelines.

We understand that in the medical industry, quality is non-negotiable, which is why our RA/QA team is dedicated to upholding the most rigorous standards of product quality, safety, and effectiveness, leaving no stone unturned to meet or exceed the stringent requirements of the healthcare and veterinary sectors.

Navigating the complex landscape of regulatory compliance is essential, and our experienced regulatory affairs professionals stay up to date with the latest regulations, working diligently to secure the necessary approvals, certifications, and registrations from CE, FDA, ISO, and other relevant authorities.

Furthermore, our commitment to Occupational Health and Safety Policy is integral to our operations, ensuring the well-being of our workforce and the quality of our products.

Technical Competencies

- Machining
- Subtractive Manufacturing
- Deep Drawing
- Die & Mold Making
- Chemical Coating
- Hard Anodization
- Silicone Forming
- Laser Welding
- OEM - ODM - PLM



Special Stackability Design



Place and Go Gasket

Shape / No Glue

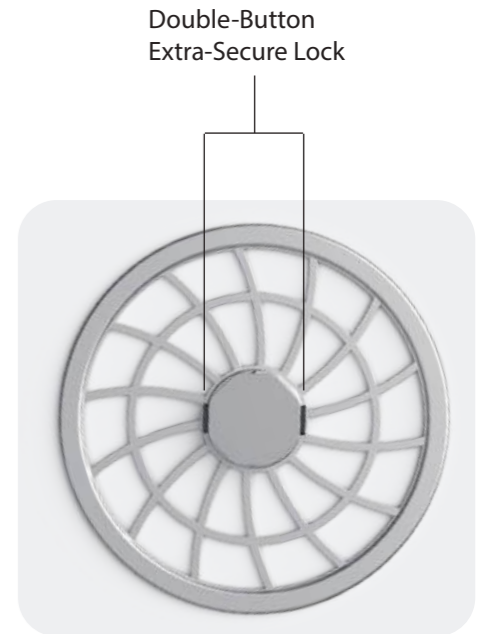

Double-Button Extra-Secure Lock

Filter Retainer With Sealing & Spring System

2 mm Aluminium Bottom & Lid

Spring-Loaded Aluminium Lock for Better Grip and Sealing

Face Plate Made of Single Block of Aluminium

Extra-Strong Silicone Coated Ergonomic Handles

OEM-PLM Marking Option





Different Lids Colors

Our sterilization containers at Victoris come in eight different colors (silver, yellow, red, blue, green, black, bronze and purple) ensuring to easily distinguish between different sets or types of instruments at a glance.



Advantages of Multiple Colors

- Enhanced Organization: Different colors can be used to categorize and organize instruments based on their usage, department, or level of sterilization, reducing the risk of cross-contamination and improving efficiency.
- Easy Identification: Color-coding helps in quickly identifying the contents of each container, saving time and reducing errors in busy environments.
- Improved Workflow: With a clear visual system in place, staff can more easily manage inventory and ensure that the right instruments are always in the right place.

Customized Solutions & Tailored to Your Needs

Victoris sterilization containers are manufactured in 8 main sizes to accommodate various surgical needs: standard sizes (1/1 Full Size, 3/4 Quarter Size, 1/2 Half Size, Mini, Dental and 1/2 Dental Size) are ideal for common instrument sets, while the Wide Body size suits specialized instruments like Bookwalter retractors, and the Long Body size is designed for extended instruments such as robotic arms.

The sterilization containers are crafted in five primary heights to suit a variety of surgical instruments. Additionally, custom sizes or heights can be tailored to meet specific requirements.

Standard 5 Different Heights For Standard & Reusable Models

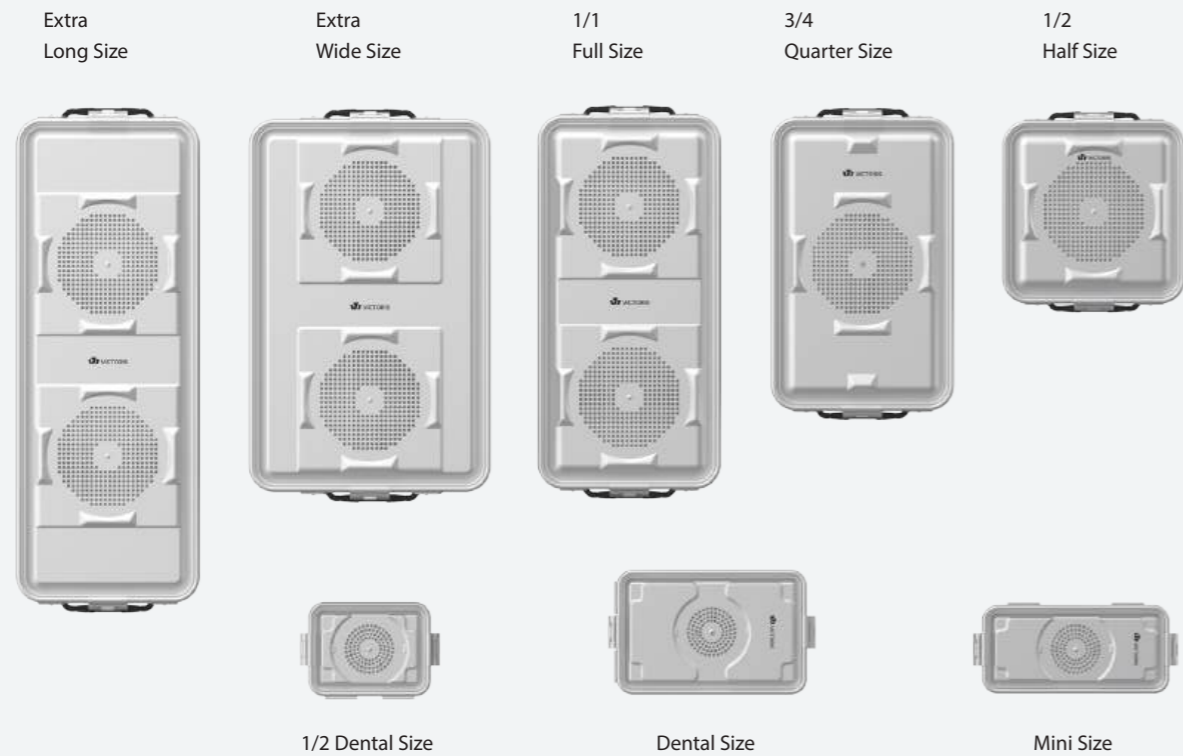

Standard 8 Different Size Types For Standard & Reusable Models

Type	Packaging according to EN 868-8		Steam sterilization procedure according to EN 285				
	Description	Symbolic Packaging	Gravity	Pre-Vacuum	Fractional Vacuum	Fractional Flow	Steam Injection
Sterilization Container with filters	Textiles in container with filter in lid and box		+	+	+	+	+
			O	O	+	+	+
	Textiles in container with filter in lid, non-perforated box		-	-	+	+	+
			-	-	+	+	O
	Textiles in container with filter in box, non-perforated lid		O	+	+	+	+
			-	O	+	+	+
	Instruments in wire basket, in sterilization filter in lid and box		+3	+	+	+	+
Sterilization Container with valves	Textiles in sterilization container with valves in lid and box		-	O	+	+	O
			-	-	+	+	O
Sterilization Container with valves	Textiles in sterilization container with valves in lid and no valves on the box		-	-	+	+	-
			-	-	+	+	-
	Instruments in wire basket in sterilization container with valve in lid and box		-	+2	+2	+2	+2
	Instruments in wire basket, in sterilization container with valve in lid and non-perforated box		-	+2	+2	+2	+2

*To prevent errors during service, operation, or loading of the autoclaves, consult above table.
 *Use only sterilization containers that guarantee proper evaporation or discharge of condensate.
 *Keep in mind that gravitation-based procedures, which lack a dedicated drying process, do not ensure sufficient after-drying effects.

STANDARD & REUSABLE MODELS

SECURE TODAY

ELEVATE TOMORROW



WHY STERILIZATION CONTAINERS?

- Consistent Processing
- Reduced Risk of Contamination
- Physical Instrument Protection
- Optimal Set Organization
- Reusability / Sustainability
- Reduced Waste
- Streamlined Process
- Easy Identification and Access
- Adherence to Standards
- Minimized Handling

Today's Safety. Tomorrow's Efficiency



Elevated Sterilization Solutions: For Your Operational Excellence

Discover our 2mm special alloy aluminum container systems that provide superior protection for your surgical instruments. Available in 8 different color palettes, they facilitate organization and quick identification. This solution supports your operational excellence by combining reliability, an eco-friendly approach, and long-term cost advantages.

SAFETY LIDS 



TWO DIFFERENT FILTER TYPES
Paper Filter or PTFE Filter



**EASE WITH COLORS
EXCELLENCE IN WORKFLOW**

 Different Lids Colors



TWO BOTTOM TYPES

 Non Perforated  Perforated



Standard Model

1/1 Full Size

 Different Lids Colors



With Safety Lid



With Perforated Lid



Non Perforated



Code Outside Dimension
Inside Dimension
L x W x H

K1-10-110 597 x 275 x 95 mm
546 x 258 x 90 mm

K1-10-135 597 x 275 x 120 mm
546 x 258 x 115 mm

K1-10-150 597 x 275 x 136 mm
546 x 258 x 131 mm

K1-10-200 597 x 275 x 188 mm
546 x 258 x 183 mm

K1-10-260 597 x 275 x 235 mm
546 x 258 x 230 mm



Perforated



Code Outside Dimension
Inside Dimension
L x W x H

KP1-10-110 597 x 275 x 95 mm
544 x 257 x 75 mm

KP1-10-135 597 x 275 x 120 mm
544 x 257 x 100 mm

KP1-10-150 597 x 275 x 136 mm
544 x 257 x 116 mm

KP1-10-200 597 x 275 x 188 mm
544 x 257 x 168 mm

KP1-10-260 597 x 275 x 235 mm
544 x 257 x 215 mm

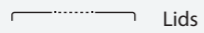

Lids



Colors Code

Grey K1-10-1
Yellow K1-10-2
Red K1-10-3
Blue K1-10-4
Green K1-10-5
Black K1-10-6
Purple K1-10-7
Bronze K1-10-8

Dimension
585 x 285 x 37 mm



Safety Lids



Colors Code

Grey KS1-10-1
Yellow KS1-10-2
Red KS1-10-3
Blue KS1-10-4
Green KS1-10-5
Black KS1-10-6
Purple KS1-10-7
Bronze KS1-10-8

Dimension
586 x 289 x 36 mm

Wire Basket



Mesh: 4x4 mm
Wire: ø 1 mm

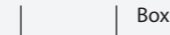

Box

Code	Outside Dimension L x W x H
B1-5425-30	540 x 245 x 30 mm
B1-5425-50	540 x 245 x 50 mm
B1-5425-70	540 x 245 x 70 mm
B1-5425-100	540 x 245 x 100 mm



Lid

Code
B1-5425
Outside Dimension
L x W x H
510 x 230 x 5 mm

Perforated Basket



Mesh: 4x4 mm
Wire: ø 1 mm



Box (with 10 mm feet)

Code	Outside Dimension L x W x H
B2-5425-30	540 x 251 x 40 mm
B2-5425-50	540 x 251 x 60 mm
B2-5425-70	540 x 251 x 80 mm
B2-5425-100	540 x 251 x 110 mm



Lid

Code
B2-5425
Outside Dimension
L x W x H
540 x 256 x 5 mm

Hybrid Basket



Mesh: 4x4 mm
Sides: ø 3 mm
Wire: ø 1 mm

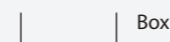

Box

Code	Outside Dimension L x W x H
B3-5425-50	540 x 255 x 50 mm
B3-5425-70	540 x 255 x 70 mm
B3-5425-100	540 x 255 x 100 mm



Lid

Code
B3-5425
Outside Dimension
L x W x H
510 x 240 x 5 mm

Silicone Mat

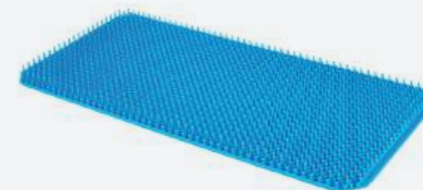

Code
A7-5425
Outside Dimension
L x W x H
500 x 235 mm

Standard Model

1/1 Full Size Baskets

Wire Basket



Perforated Basket



Hybrid Basket



Standard Model

3/4 Quarter Size

 Different Lids Colors



With Safety Lid



With Perforated Lid



Non Perforated



Code Outside Dimension
Inside Dimension
L x W x H

K1-20-110 477 x 275 x 95 mm
423 x 258 x 90 mm

K1-20-135 477 x 275 x 120 mm
423 x 258 x 115 mm

K1-20-150 477 x 275 x 136 mm
423 x 258 x 131 mm

K1-20-200 477 x 275 x 188 mm
423 x 258 x 183 mm



Perforated



Code Outside Dimension
Inside Dimension
L x W x H

KP1-20-110 477 x 275 x 95 mm
423 x 258 x 75 mm

KP1-20-135 477 x 275 x 120 mm
423 x 258 x 100 mm

KP1-20-150 477 x 275 x 136 mm
423 x 258 x 116 mm

KP1-20-200 477 x 275 x 188 mm
423 x 258 x 168 mm

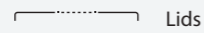

Lids



Colors Code

Grey K1-20-1

Yellow K1-20-2

Red K1-20-3

Blue K1-20-4

Green K1-20-5

Black K1-20-6

Purple K1-20-7

Bronze K1-20-8

Dimension
465 x 280 x 37 mm



Safety Lids



Colors Code

Grey KS1-20-1

Yellow KS1-20-2

Red KS1-20-3

Blue KS1-20-4

Green KS1-20-5

Black KS1-20-6

Purple KS1-20-7

Bronze KS1-20-8

Dimension
465 x 289 x 36 mm

Standard Model

3/4 Quarter Size Baskets

Wire Basket



Mesh: 4x4 mm
Wire: ø 1 mm

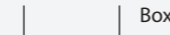

Box

Code	Outside Dimension L x W x H
B1-4025-30	405 x 245 x 30 mm
B1-4025-50	405 x 245 x 50 mm
B1-4025-70	405 x 245 x 70 mm
B1-4025-100	405 x 245 x 100 mm



Lid

Code	Outside Dimension L x W x H
B1-4025	375 x 230 x 5 mm

Perforated Basket



Mesh: 4x4 mm
Wire: ø 1 mm

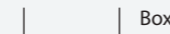

Box (with 10 mm feet)

Code	Outside Dimension L x W x H
B2-4025-30	403 x 251 x 40 mm
B2-4025-50	403 x 251 x 60 mm
B2-4025-70	403 x 251 x 80 mm
B2-4025-100	403 x 251 x 110 mm



Lid

Code	Outside Dimension L x W x H
B2-4025	405 x 256 x 5 mm

Hybrid Basket



Mesh: 4x4 mm
Sides: ø 3 mm
Wire: ø 1 mm

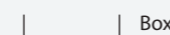

Box

Code	Outside Dimension L x W x H
B3-4025-50	405 x 255 x 50 mm
B3-4025-70	405 x 255 x 70 mm
B3-4025-100	405 x 255 x 100 mm



Lid

Code	Outside Dimension L x W x H
B3-4025	375 x 240 x 5 mm

Silicone Mat



Code
A7-4025
Outside Dimension
L x W x H
370 x 235 mm

Wire Basket

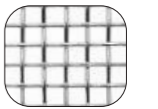

Perforated Basket



Hybrid Basket

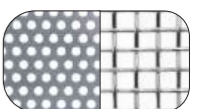

Standard Model

1/2 Half Size

 Different Lids Colors



With Safety Lid



With Perforated Lid



Non Perforated



Code Outside Dimension
Inside Dimension
L x W x H

K1-30-110 307 x 275 x 95 mm
258 x 258 x 90 mm

K1-30-135 307 x 275 x 120 mm
258 x 258 x 115 mm

K1-30-150 307 x 275 x 136 mm
258 x 258 x 131 mm

K1-30-200 307 x 275 x 188 mm
258 x 258 x 183 mm

K1-30-260 307 x 275 x 235 mm
258 x 258 x 230 mm

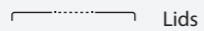

Lids



Colors Code

Grey K1-30-1

Yellow K1-30-2

Red K1-30-3

Blue K1-30-4

Green K1-30-5

Black K1-30-6

Purple K1-30-7

Bronze K1-30-8

Dimension
295 x 280 x 37 mm



Perforated



Code Outside Dimension
Inside Dimension
L x W x H

KP1-30-110 307 x 275 x 95 mm
258 x 258 x 75 mm

KP1-30-135 307 x 275 x 120 mm
258 x 258 x 100 mm

KP1-30-150 307 x 275 x 136 mm
258 x 258 x 116 mm

KP1-30-200 307 x 275 x 188 mm
258 x 258 x 168 mm

KP1-30-260 307 x 275 x 235 mm
258 x 258 x 215 mm



Safety Lids



Colors Code

Grey KS1-30-1

Yellow KS1-30-2

Red KS1-30-3

Blue KS1-30-4

Green KS1-30-5

Black KS1-30-6

Purple KS1-30-7

Bronze KS1-30-8

Dimension
295 x 289 x 36 mm

Wire Basket



Mesh: 4x4 mm
Wire: ø 1 mm

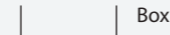

Box

Code	Outside Dimension L x W x H
B1-2525-30	246 x 246 x 30 mm
B1-2525-50	246 x 246 x 50 mm
B1-2525-70	246 x 246 x 70 mm
B1-2525-100	246 x 246 x 100 mm



Lid

Code	Outside Dimension L x W x H
B1-2525	240 x 215 x 5 mm

Perforated Basket



Mesh: 4x4 mm
Wire: ø 1 mm

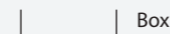

Box (with 10 mm feet)

Code	Outside Dimension L x W x H
B2-2525-30	244 x 250 x 40 mm
B2-2525-50	244 x 250 x 60 mm
B2-2525-70	244 x 250 x 80 mm
B2-2525-100	244 x 250 x 110 mm



Lid

Code	Outside Dimension L x W x H
B2-2525	247 x 256 x 5 mm

Hybrid Basket



Mesh: 4x4 mm
Sides: ø 3 mm
Wire: ø 1 mm

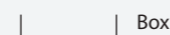

Box

Code	Outside Dimension L x W x H
B3-2525-50	245 x 255 x 50 mm
B3-2525-70	245 x 255 x 70 mm
B3-2525-100	245 x 255 x 100 mm



Lid

Code	Outside Dimension L x W x H
B3-2525	215 x 240 x 5 mm

Silicone Mat



Code	Outside Dimension L x W x H
A7-2525	225 x 235 mm

Standard Model

1/2 Half Size Baskets

Wire Basket

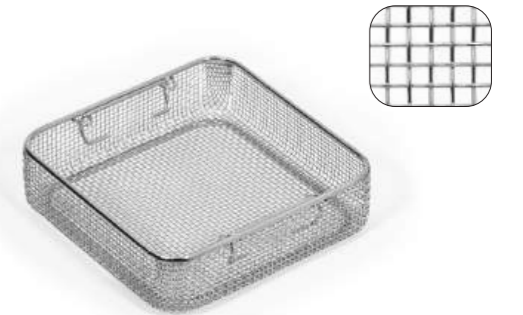

Perforated Basket



Hybrid Basket



Standard Model

Long Size

 Different Lids Colors



With Perforated Lid



With Color Options



Non Perforated



Code Outside Dimension
Inside Dimension
L x W x H

K1-40-150 770 x 275 x 136 mm
715 x 258 x 131 mm

K1-40-200 770 x 275 x 188 mm
715 x 258 x 183 mm



Perforated



Code Outside Dimension
Inside Dimension
L x W x H

KP1-40-150 770 x 275 x 136 mm
715 x 258 x 116 mm

KP1-40-200 770 x 275 x 188 mm
715 x 258 x 168 mm

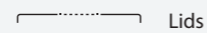

Lids

Colors Code

Grey K1-40-1

Yellow K1-40-2

Red K1-40-3

Blue K1-40-4

Green K1-40-5

Black K1-40-6

Purple K1-40-7

Bronze K1-40-8

Dimension
758 x 280 x 37 mm



Wire Basket



Box

Code Outside Dimension
L x W x H

B1-6625-50 665 x 245 x 50 mm

B1-6625-70 665 x 245 x 70 mm

B1-6625-100 665 x 245 x 100 mm

Mesh: 4x4 mm
Wire: ø 1 mm



Lid

Code
B1-6625

Outside Dimension
L x W x H
635 x 230 x 5 mm

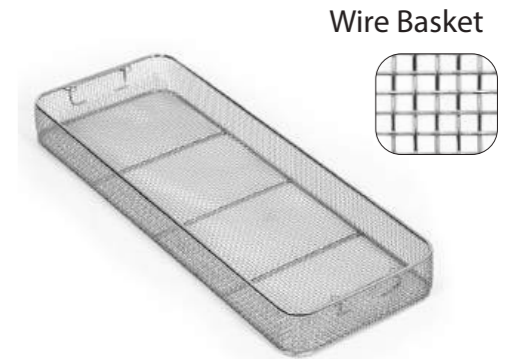

Wire Basket

Perforated Basket

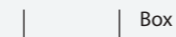

Box (with 10 mm feet)

Code Outside Dimension
L x W x H

B2-6625-30 650 x 251 x 40 mm

B2-6625-50 650 x 251 x 60 mm

B2-6625-70 650 x 251 x 80 mm

B2-6625-100 650 x 251 x 110 mm

Mesh: 4x4 mm
Wire: ø 1 mm



Lid

Code
B2-6625

Outside Dimension
L x W x H
652 x 256 x 5 mm

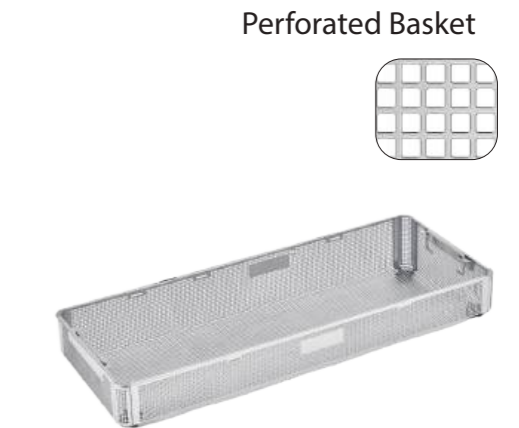

Perforated Basket

Hybrid Basket

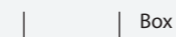

Box

Code Outside Dimension
L x W x H

B3-6625-50 665 x 255 x 50 mm

B3-6625-70 665 x 255 x 70 mm

B3-6625-100 665 x 255 x 100 mm

Mesh: 4x4 mm
Sides: ø 3 mm
Wire: ø 1 mm



Lid

Code
B3-6625

Outside Dimension
L x W x H
635 x 240 x 5 mm



Hybrid Basket

Standard Model

Long Size Baskets

Standard Model

Wide Size

 Different Lids Colors



With Perforated Lid



With Color Options



Code Outside Dimension
Inside Dimension
L x W x H

K1-50-110 597 x 365 x 105 mm
546 x 348 x 100 mm

K1-50-170 597 x 365 x 165 mm
546 x 348 x 160 mm



Code Outside Dimension
Inside Dimension
L x W x H

KP1-50-110 597 x 365 x 105 mm
546 x 348 x 85 mm

KP1-50-170 597 x 365 x 165 mm
546 x 348 x 145 mm

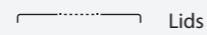

Colors Code

Grey K1-50-1

Yellow K1-50-2

Red K1-50-3

Blue K1-50-4

Green K1-50-5

Black K1-50-6

Purple K1-50-7

Bronze K1-50-8

Dimension
585 x 370 x 37 mm

Wire Basket



Code Outside Dimension
L x W x H

B1-5333-50 533 x 337 x 50 mm

B1-5333-70 533 x 337 x 70 mm

B1-5333-100 533 x 337 x 100 mm

Mesh: 4x4 mm
Wire: ø 1 mm



Code
B1-5333

Outside Dimension
L x W x H
503 x 322 x 5 mm

Perforated Basket

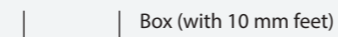

Code Outside Dimension
L x W x H

B2-5333-30 535 x 340 x 40 mm

B2-5333-50 535 x 340 x 60 mm

B2-5333-70 535 x 340 x 80 mm

B2-5333-100 535 x 340 x 110 mm

Mesh: 4x4 mm
Wire: ø 1 mm



Code
B2-5333

Outside Dimension
L x W x H
537 x 343 x 5 mm

Hybrid Basket

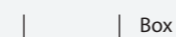

Code Outside Dimension
L x W x H

B3-5333-50 533 x 337 x 50 mm

B3-5333-70 533 x 337 x 70 mm

B3-5333-100 533 x 337 x 100 mm

Mesh: 4x4 mm
Sides: ø 3 mm
Wire: ø 1 mm

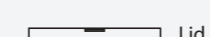

Code
B3-5333

Outside Dimension
L x W x H
503 x 322 x 5 mm

Standard Model

Wide Size Baskets

Wire Basket

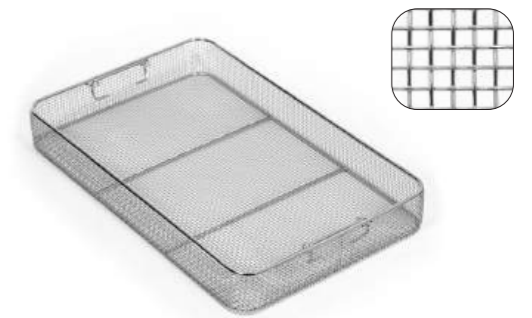

Perforated Basket



Hybrid Basket



Standard Model

Flat Size

 Different Lids Colors



With Perforated Lid



With Color Options



 Non Perforated

Code Outside Dimension
 Inside Dimension
 L x W x H

K1-90-45 297 x 275 x 55 mm
 258 x 258 x 50 mm

K1-90-75 297 x 275 x 75 mm
 258 x 258 x 70 mm



 Lids

Colors Code

Grey K1-90-1

Yellow K1-90-2

Red K1-90-3

Blue K1-90-4

Green K1-90-5

Black K1-90-6

Purple K1-90-7

Bronze K1-90-8

Dimension
295 x 280 x 37 mm

Wire Basket



Mesh: 4x4 mm
Wire: ø 1 mm

 Box

Code Outside Dimension
 L x W x H

B1-2525-30 246 x 246 x 30 mm

B1-2525-50 246 x 246 x 50 mm

 Lid

Code
B1-2525

Outside Dimension
L x W x H
240 x 215 x 5 mm

Perforated Basket



Mesh: 4x4 mm
Wire: ø 1 mm

 Box (with 10 mm feet)

Code Outside Dimension
 L x W x H

B2-2525-30 244 x 250 x 40 mm

B2-2525-50 244 x 250 x 60 mm

 Lid

Code
B2-2525

Outside Dimension
L x W x H
247 x 256 x 5 mm

Silicone Mat



Code
A7-2525

Outside Dimension
L x W x H
225 x 235 mm

Standard Model

Flat Size Baskets

Wire Basket

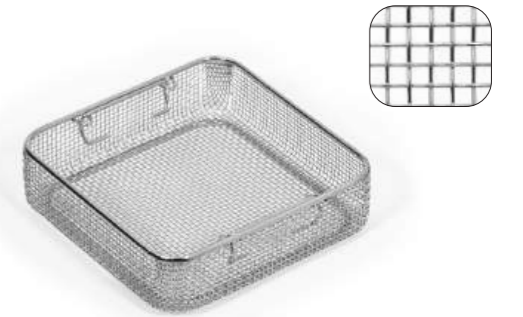

Perforated Basket

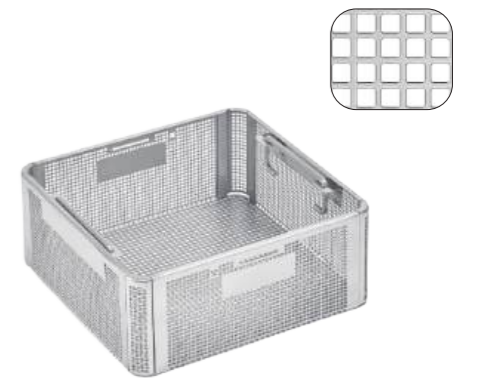

Standard Model

Mini Size

 Different Lids Colors



With Perforated Lid



With Color Options



Code	Outside Dimension Inside Dimension L x W x H
K1-70-40	305 x 135 x 45 mm 272 x 125 x 33 mm
K1-70-70	305 x 135 x 60 mm 272 x 125 x 48 mm
K1-70-100	305 x 135 x 90 mm 272 x 125 x 78 mm
K1-70-130	305 x 135 x 120 mm 272 x 125 x 108 mm

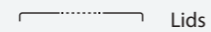

Colors	Code
Grey	K1-70-1
Yellow	K1-70-2
Red	K1-70-3
Blue	K1-70-4
Green	K1-70-5
Black	K1-70-6
Purple	K1-70-7
Bronze	K1-70-8

Dimension
303 x 136 x 29 mm

Wire Basket



Mesh: 4x4 mm
Wire: ø 1 mm



Code	Outside Dimension L x W x H
B1-2712-40	268 x 117 x 40 mm
B1-2712-100	268 x 117 x 100 mm



Code	Outside Dimension L x W x H
B1-2712	250 x 120 x 5 mm

Perforated Basket



Mesh: 4x4 mm
Wire: ø 1 mm



Code	Outside Dimension L x W x H
B2-2712-40	260 x 120 x 50 mm
B2-2712-100	260 x 120 x 110 mm



Code	Outside Dimension L x W x H
B2-2712	262 x 122 x 5 mm

Silicone Mat



Code
A7-2712
Outside Dimension
L x W x H
270 x 125 mm

Standard Model

Mini Size Baskets

Wire Basket



Perforated Basket

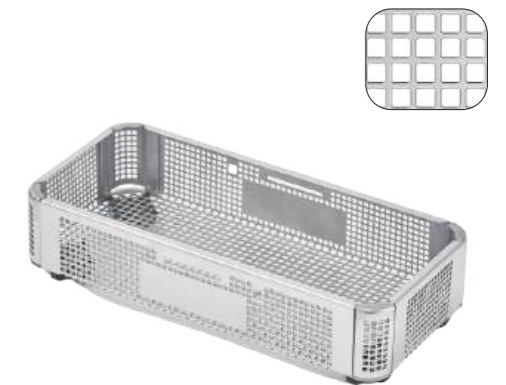

Standard Model

Dental Size

 Different Lids Colors



With Perforated Lid



With Color Options



Code	Outside Dimension Inside Dimension L x W x H
K1-60-40	310 x 189 x 45 mm 277 x 180 x 33 mm
K1-60-70	310 x 189 x 60 mm 277 x 180 x 48 mm
K1-60-100	310 x 189 x 90 mm 277 x 180 x 78 mm
K1-60-130	310 x 189 x 120 mm 277 x 180 x 108 mm

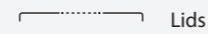

Colors	Code
Grey	K1-60-1
Yellow	K1-60-2
Red	K1-60-3
Blue	K1-60-4
Green	K1-60-5
Black	K1-60-6
Purple	K1-60-7
Bronze	K1-60-8

Dimension
308 x 190 x 29 mm

Wire Basket



Mesh: \varnothing 4x4 mm
Wire: \varnothing 1 mm



Code	Outside Dimension L x W x H
B1-2717-40	270 x 170 x 40 mm
B1-2717-100	270 x 170 x 100 mm



Code
B1-2717
Outside Dimension
L x W x H
252 x 172 x 5 mm

Perforated Basket



Mesh: \varnothing 4x4 mm
Wire: \varnothing 1 mm

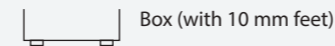

Code	Outside Dimension L x W x H
B2-2717-40	273 x 172 x 50 mm
B2-2717-100	273 x 172 x 110 mm



Code
B2-2717
Outside Dimension
L x W x H
275 x 174 x 5 mm

Standard Model

Dental Size Baskets

Wire Basket

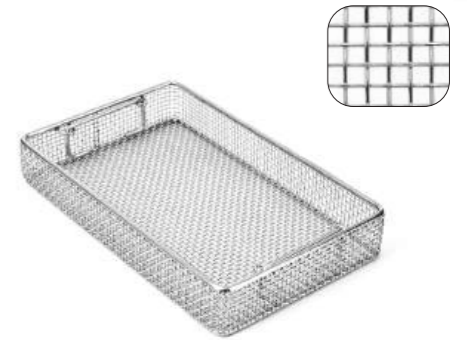

Perforated Basket



Standard Model

1/2 Dental Size

 Different Lids Colors



With Perforated Lid



With Color Options



Code	Outside Dimension Inside Dimension L x W x H
K1-80-40	207 x 144 x 45 mm 174 x 135 x 33 mm
K1-80-70	207 x 144 x 60 mm 174 x 135 x 48 mm
K1-80-100	207 x 144 x 90 mm 174 x 135 x 78 mm
K1-80-130	207 x 144 x 120 mm 174 x 135 x 108 mm

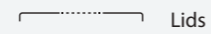

Colors	Code
Grey	K1-80-1
Yellow	K1-80-2
Red	K1-80-3
Blue	K1-80-4
Green	K1-80-5
Black	K1-80-6
Purple	K1-80-7
Bronze	K1-80-8

Dimension
205 x 145 x 29 mm

Wire Basket



Mesh: \varnothing 4x4 mm
Wire: \varnothing 1 mm



Code	Outside Dimension L x W x H
B1-1714-40	165 x 130 x 35 mm
B1-1714-100	165 x 130 x 100 mm



Code
B1-1714
Outside Dimension
L x W x H
147 x 132 x 5 mm



Wire Basket

Perforated Basket



Mesh: \varnothing 4x4 mm
Wire: \varnothing 1 mm

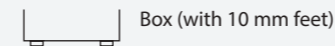

Code	Outside Dimension L x W x H
B2-1714-40	165 x 130 x 45 mm
B2-1714-100	165 x 130 x 100 mm



Code
B2-1714
Outside Dimension
L x W x H
167 x 130 x 5 mm



Perforated Basket

Standard Model

1/2 Dental Size Baskets

Clean. Safe. Sustainable.

2 Different Filtering System
Mechanical Valve System & Barrier System



Different Lids Colors

BARRIER MODEL

The Barrier Model is an innovative sterilization container designed to ensure maximum safety in CSSD workflows. Its labyrinth structure prevents microorganisms from entering, maintaining sterility for extended periods. This design offers reliable, practical, and scientifically proven protection.

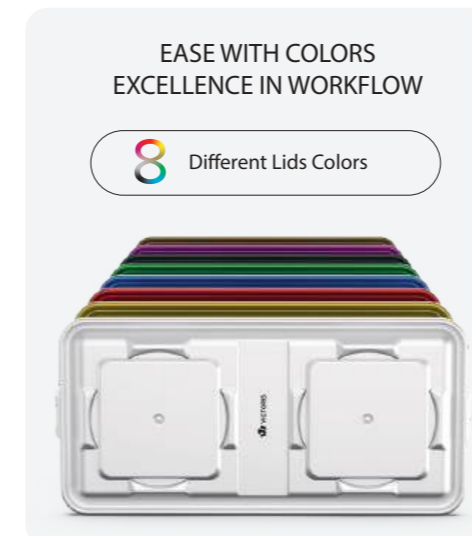
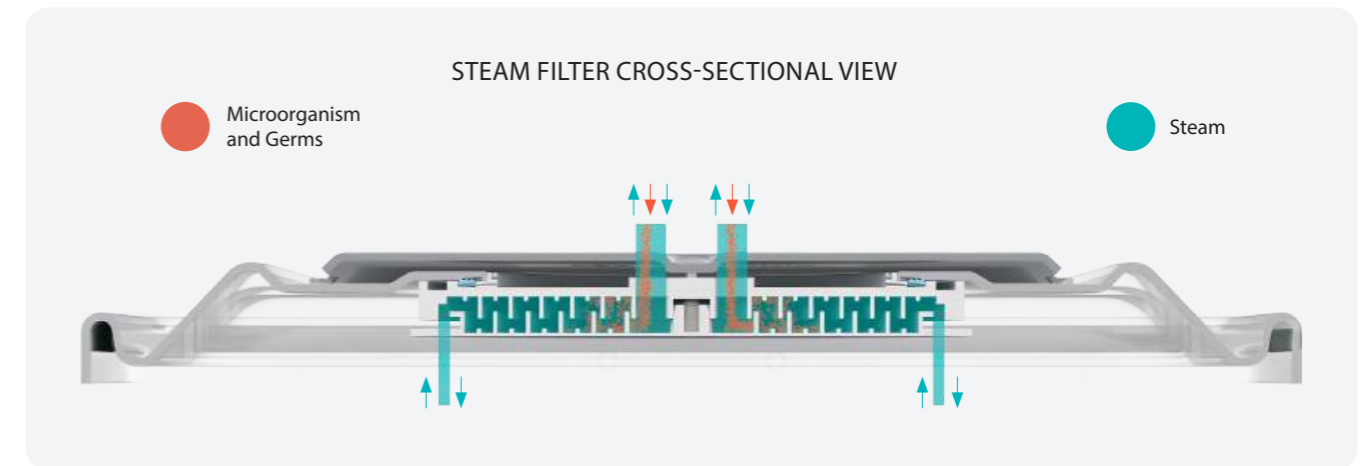

Scientific Foundation

The principle behind the Barrier mechanism traces back to Louis Pasteur's groundbreaking "Swan Neck Flask" experiment in 1862, which challenged the idea of spontaneous generation. Pasteur designed a flask with an S-shaped neck that allowed air to pass freely but trapped dust and microorganisms in its curves. When the broth inside was boiled and left untouched, no microbial growth occurred, clearly proving that life could not emerge without contamination from existing microorganisms. However, once the flask was tilted and the trapped particles reached the broth, microbial growth appeared almost immediately.

The Barrier Model adopts the same principle through its labyrinth-like system. By forcing air to travel through a complex path, it prevents microorganisms and viruses from penetrating the container. This ensures that sterility is maintained, while still allowing necessary airflow. The result is a reliable and scientifically validated protective system, directly inspired by one of the most important experiments in microbiology.



REDUCE. REUSE. RENEW.

Seize Cost Control and Sustainability: Ditch the waste expense and embrace the smart, permanent solution.



VALVE MODEL

Victoris Valve Model sterilization containers are designed with an advanced mechanical valve system that removes the need for disposable filters while delivering stable and reliable performance throughout extended use.

Each valve is precisely engineered with integrated gaskets that ensure smooth operation in response to pressure variations during the sterilization process. The secure closure, supported by high-grade silicone gaskets, provides excellent sealing integrity and long-term durability.

Combining innovative design with practicality, Victoris Valve Model containers offer a sustainable and cost-efficient solution for safe and effective sterilization in healthcare environments worldwide.

EASE WITH COLORS EXCELLENCE IN WORKFLOW

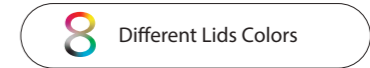

RUNNING PRINCIPLE

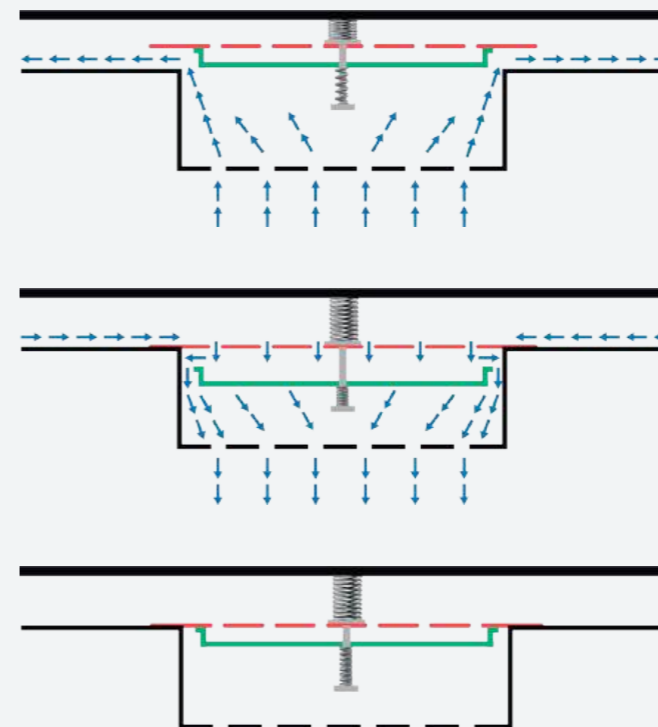

At the beginning of the sterilization cycle, the vacuum phase causes the valves to fully open, allowing the evacuation of dry air from the container.

During the sterilization cycle, the pressure-activated valves automatically open under positive pressure, enabling controlled steam penetration for effective sterilization.

Once the process is complete, and no external forces such as vacuum or pressure are present, the entire system remains sealed, preserving the sterility of its contents.

Reusable Model

1/1 Full Size

 Different Lids Colors



With Reusable Mechanism



With Color Options



Code	Outside Dimension Inside Dimension L x W x H
K1-10-110	597 x 275 x 95 mm 546 x 258 x 90 mm
K1-10-135	597 x 275 x 120 mm 546 x 258 x 115 mm
K1-10-150	597 x 275 x 136 mm 546 x 258 x 131 mm
K1-10-200	597 x 275 x 188 mm 546 x 258 x 183 mm
K1-10-260	597 x 275 x 235 mm 546 x 258 x 230 mm



Colors	Code
Grey	K2-10-1
Yellow	K2-10-2
Red	K2-10-3
Blue	K2-10-4
Green	K2-10-5
Black	K2-10-6
Purple	K2-10-7
Bronze	K2-10-8

Dimension
585 x 280 x 37 mm



Colors	Code
Grey	K3-10-1
Yellow	K3-10-2
Red	K3-10-3
Blue	K3-10-4
Green	K3-10-5
Black	K3-10-6
Purple	K3-10-7
Bronze	K3-10-8

Dimension
585 x 280 x 37 mm

Wire Basket



Mesh: 4x4 mm
Wire: ø 1 mm

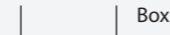

Code	Outside Dimension L x W x H
B1-5425-30	540 x 245 x 30 mm
B1-5425-50	540 x 245 x 50 mm
B1-5425-70	540 x 245 x 70 mm
B1-5425-100	540 x 245 x 100 mm



Code
B1-5425
Outside Dimension
L x W x H
510 x 230 x 5 mm

Perforated Basket



Mesh: 4x4 mm
Wire: ø 1 mm

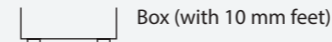

Code	Outside Dimension L x W x H
B2-5425-30	540 x 251 x 40 mm
B2-5425-50	540 x 251 x 60 mm
B2-5425-70	540 x 251 x 80 mm
B2-5425-100	540 x 251 x 110 mm



Code
B2-5425
Outside Dimension
L x W x H
540 x 256 x 5 mm

Hybrid Basket



Mesh: 4x4 mm
Sides: ø 3 mm
Wire: ø 1 mm

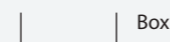

Code	Outside Dimension L x W x H
B3-5425-50	540 x 255 x 50 mm
B3-5425-70	540 x 255 x 70 mm
B3-5425-100	540 x 255 x 100 mm



Code
B3-5425
Outside Dimension
L x W x H
510 x 240 x 5 mm

Silicone Mat

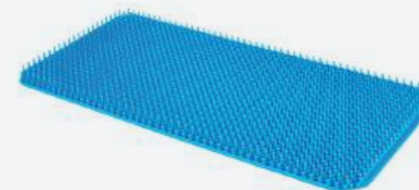

Code
A7-5425
Outside Dimension
L x W x H
500 x 235 mm

Reusable Model

1/1 Full Size Baskets

Wire Basket



Perforated Basket



Hybrid Basket



Reusable Model

3/4 Quarter Size

 Different Lids Colors



With Reusable Mechanism



With Color Options



Non Perforated

Code	Outside Dimension Inside Dimension L x W x H
K1-20-110	477 x 275 x 95 mm 423 x 258 x 90 mm
K1-20-135	477 x 275 x 120 mm 423 x 258 x 115 mm
K1-20-150	477 x 275 x 136 mm 423 x 258 x 131 mm
K1-20-200	477 x 275 x 188 mm 423 x 258 x 183 mm



Valve Lids

Colors	Code
Grey	K2-20-1
Yellow	K2-20-2
Red	K2-20-3
Blue	K2-20-4
Green	K2-20-5
Black	K2-20-6
Purple	K2-20-7
Bronze	K2-20-8

Dimension
465 x 280 x 37 mm



Barrier Lids

Colors	Code
Grey	K3-20-1
Yellow	K3-20-2
Red	K3-20-3
Blue	K3-20-4
Green	K3-20-5
Black	K3-20-6
Purple	K3-20-7
Bronze	K3-20-8

Dimension
465 x 280 x 37 mm

Wire Basket



Mesh: 4x4 mm
Wire: ø 1 mm

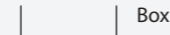

Box

Code	Outside Dimension L x W x H
B1-4025-30	405 x 245 x 30 mm
B1-4025-50	405 x 245 x 50 mm
B1-4025-70	405 x 245 x 70 mm
B1-4025-100	405 x 245 x 100 mm



Lid

Code	Outside Dimension L x W x H
B1-4025	375 x 230 x 5 mm

Perforated Basket



Mesh: 4x4 mm
Wire: ø 1 mm

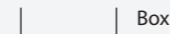

Box (with 10 mm feet)

Code	Outside Dimension L x W x H
B2-4025-30	403 x 251 x 40 mm
B2-4025-50	403 x 251 x 60 mm
B2-4025-70	403 x 251 x 80 mm
B2-4025-100	403 x 251 x 110 mm



Lid

Code	Outside Dimension L x W x H
B2-4025	405 x 256 x 5 mm

Hybrid Basket



Mesh: 4x4 mm
Sides: ø 3 mm
Wire: ø 1 mm

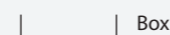

Box

Code	Outside Dimension L x W x H
B3-4025-50	405 x 255 x 50 mm
B3-4025-70	405 x 255 x 70 mm
B3-4025-100	405 x 255 x 100 mm



Lid

Code	Outside Dimension L x W x H
B3-4025	375 x 240 x 5 mm

Silicone Mat

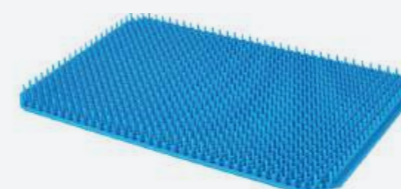

Code	Outside Dimension L x W x H
A7-4025	370 x 235 mm

Reusable Model

3/4 Quarter Size Baskets

Wire Basket

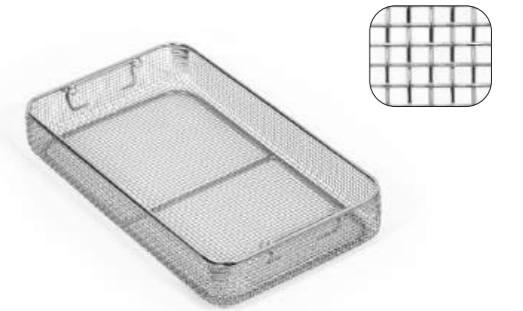

Perforated Basket



Hybrid Basket



Reusable Model

1/2 Half Size

Different Lids Colors



With Reusable Mechanism



With Color Options



Non Perforated

Code	Outside Dimension Inside Dimension L x W x H
K1-30-110	307 x 275 x 95 mm 258 x 258 x 90 mm
K1-30-135	307 x 275 x 120 mm 258 x 258 x 115 mm
K1-30-150	307 x 275 x 136 mm 258 x 258 x 131 mm
K1-30-200	307 x 275 x 188 mm 258 x 258 x 183 mm
K1-30-260	307 x 275 x 235 mm 258 x 258 x 230 mm



Valve Lids

Colors	Code
Grey	K2-30-1
Yellow	K2-30-2
Red	K2-30-3
Blue	K2-30-4
Green	K2-30-5
Black	K2-30-6
Purple	K2-30-7
Bronze	K2-30-8

Dimension
295 x 280 x 37 mm



Barrier Lids

Colors	Code
Grey	K3-30-1
Yellow	K3-30-2
Red	K3-30-3
Blue	K3-30-4
Green	K3-30-5
Black	K3-30-6
Purple	K3-30-7
Bronze	K3-30-8

Dimension
295 x 280 x 37 mm

Wire Basket



Mesh: 4x4 mm
Wire: ø 1 mm

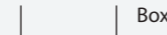

Box



Lid

Code	Outside Dimension L x W x H
B1-2525-30	246 x 246 x 30 mm
B1-2525-50	246 x 246 x 50 mm
B1-2525-70	246 x 246 x 70 mm
B1-2525-100	246 x 246 x 100 mm

Code	Outside Dimension L x W x H
B1-2525	240 x 215 x 5 mm

Perforated Basket



Mesh: 4x4 mm
Wire: ø 1 mm

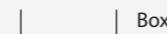

Box (with 10 mm feet)



Lid

Code	Outside Dimension L x W x H
B2-2525-30	244 x 250 x 40 mm
B2-2525-50	244 x 250 x 60 mm
B2-2525-70	244 x 250 x 80 mm
B2-2525-100	244 x 250 x 110 mm

Code	Outside Dimension L x W x H
B2-2525	247 x 256 x 5 mm

Hybrid Basket



Mesh: 4x4 mm
Sides: ø 3 mm
Wire: ø 1 mm

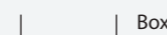

Box



Lid

Code	Outside Dimension L x W x H
B3-2525-50	245 x 255 x 50 mm
B3-2525-70	245 x 255 x 70 mm
B3-2525-100	245 x 255 x 100 mm

Code	Outside Dimension L x W x H
B3-2525	215 x 240 x 5 mm

Silicone Mat



Code	Outside Dimension L x W x H
A7-2525	225 x 235 mm

Reusable Model

1/2 Half Size Baskets

Wire Basket

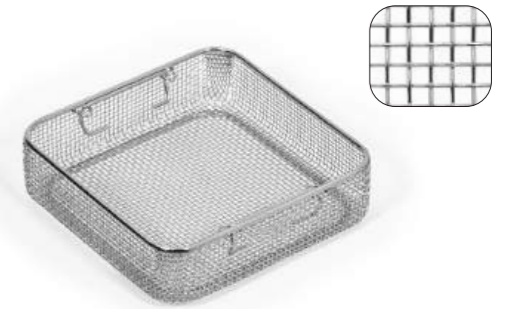

Perforated Basket



Hybrid Basket



Reusable Model

Long Size

 Different Lids Colors



With Reusable Mechanism



With Color Options



Code	Outside Dimension Inside Dimension L x W x H
K1-40-150	770 x 275 x 136 mm 715 x 258 x 131 mm
K1-40-200	770 x 275 x 188 mm 715 x 258 x 183 mm



Colors	Code
Grey	K2-40-1
Yellow	K2-40-2
Red	K2-40-3
Blue	K2-40-4
Green	K2-40-5
Black	K2-40-6
Purple	K2-40-7
Bronze	K2-40-8

Dimension
758 x 280 x 37 mm



Colors	Code
Grey	K3-40-1
Yellow	K3-40-2
Red	K3-40-3
Blue	K3-40-4
Green	K3-40-5
Black	K3-40-6
Purple	K3-40-7
Bronze	K3-40-8

Dimension
758 x 280 x 37 mm

Wire Basket

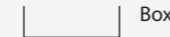

Code	Outside Dimension L x W x H
B1-6625-50	665 x 245 x 50 mm
B1-6625-70	665 x 245 x 70 mm
B1-6625-100	665 x 245 x 100 mm

Mesh: 4x4 mm
Wire: ø 1 mm



Code	Outside Dimension L x W x H
B1-6625	635 x 230 x 5 mm

Perforated Basket

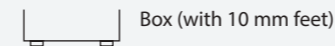

Code	Outside Dimension L x W x H
B2-6625-30	650 x 251 x 40 mm
B2-6625-50	650 x 251 x 60 mm
B2-6625-70	650 x 251 x 80 mm
B2-6625-100	650 x 251 x 110 mm

Mesh: 4x4 mm
Wire: ø 1 mm



Code	Outside Dimension L x W x H
B2-6625	652 x 256 x 5 mm

Hybrid Basket

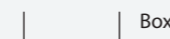

Code	Outside Dimension L x W x H
B3-6625-50	665 x 255 x 50 mm
B3-6625-70	665 x 255 x 70 mm
B3-6625-100	665 x 255 x 100 mm

Mesh: 4x4 mm
Sides: ø 3 mm
Wire: ø 1 mm



Code	Outside Dimension L x W x H
B3-6625	635 x 240 x 5 mm

Reusable Model

Long Size Baskets

Wire Basket

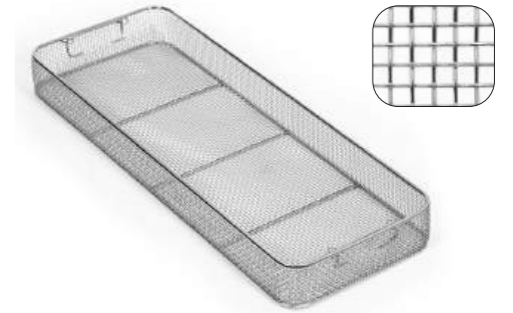

Perforated Basket

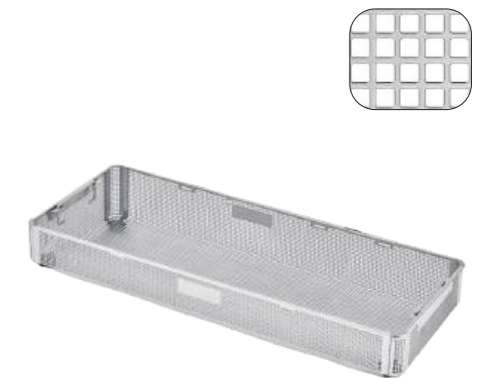

Hybrid Basket



Reusable Model

Wide Size

 Different Lids Colors



With Reusable Mechanism



With Color Options

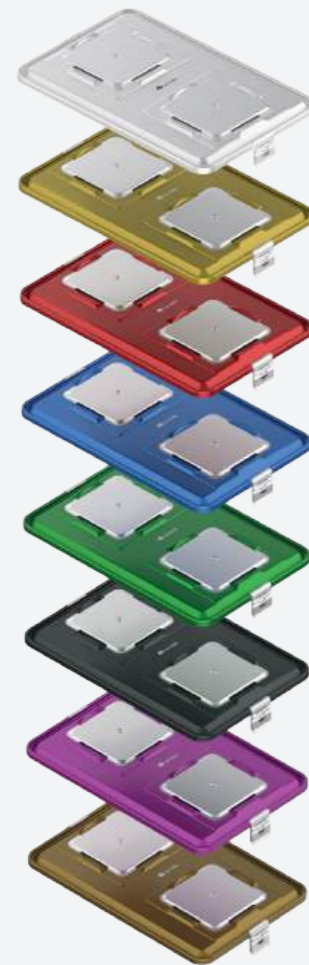

Code	Outside Dimension Inside Dimension L x W x H
K1-50-110	597 x 365 x 105 mm 546 x 348 x 100 mm
K1-50-170	597 x 365 x 165 mm 546 x 348 x 160 mm



Colors	Code
Grey	K2-50-1
Yellow	K2-50-2
Red	K2-50-3
Blue	K2-50-4
Green	K2-50-5
Black	K2-50-6
Purple	K2-50-7
Bronze	K2-50-8

Dimension
585 x 370 x 37mm



Colors	Code
Grey	K3-50-1
Yellow	K3-50-2
Red	K3-50-3
Blue	K3-50-4
Green	K3-50-5
Black	K3-50-6
Purple	K3-50-7
Bronze	K3-50-8

Dimension
585 x 370 x 37mm

Wire Basket



Mesh: 4x4 mm
Wire: ø 1 mm

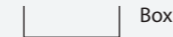

Code	Outside Dimension L x W x H
B1-5333-50	533 x 337 x 50 mm
B1-5333-70	533 x 337 x 70 mm
B1-5333-100	533 x 337 x 100 mm

Code	Outside Dimension L x W x H
B1-5333	503 x 322 x 5 mm

Perforated Basket



Mesh: 4x4 mm
Wire: ø 1 mm

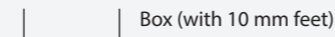

Code	Outside Dimension L x W x H
B2-5333-30	535 x 340 x 40 mm
B2-5333-50	535 x 340 x 60 mm
B2-5333-70	535 x 340 x 80 mm
B2-5333-100	535 x 340 x 110 mm

Code	Outside Dimension L x W x H
B2-5333	537 x 343 x 5 mm

Hybrid Basket



Mesh: 4x4 mm
Sides: ø 3 mm
Wire: ø 1 mm

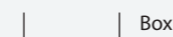

Code	Outside Dimension L x W x H
B3-5333-50	533 x 337 x 50 mm
B3-5333-70	533 x 337 x 70 mm
B3-5333-100	533 x 337 x 100 mm

Code	Outside Dimension L x W x H
B3-5333	503 x 322 x 5 mm

Reusable Model

Wide Size Baskets

Wire Basket

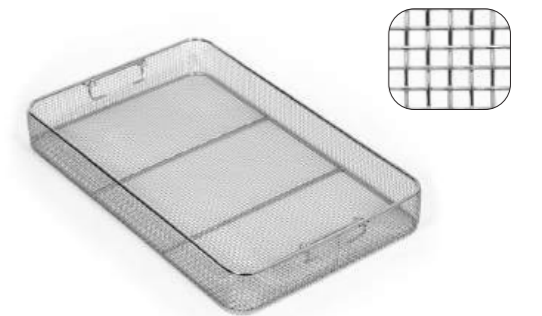

Perforated Basket



Hybrid Basket



Reusable Model

Flat Size

 Different Lids Colors



With Reusable Mechanism



With Color Options



Code	Outside Dimension Inside Dimension L x W x H
K1-90-75	297 x 275 x 75 mm 258 x 258 x 70 mm



Colors	Code
Grey	K3-90-1
Yellow	K3-90-2
Red	K3-90-3
Blue	K3-90-4
Green	K3-90-5
Black	K3-90-6
Purple	K3-90-7
Bronze	K3-90-8

Dimension
295 x 280 x 37 mm

Wire Basket



Mesh: 4x4 mm
Wire: ø 1 mm



Code	Outside Dimension L x W x H
B1-2525-30	246 x 246 x 30 mm
B1-2525-50	246 x 246 x 50 mm

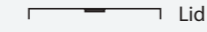

Code	Outside Dimension L x W x H
B1-2525	240 x 215 x 5 mm

Perforated Basket



Mesh: 4x4 mm
Wire: ø 1 mm

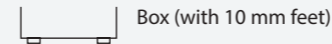

Code	Outside Dimension L x W x H
B2-2525-30	244 x 250 x 40 mm
B2-2525-50	244 x 250 x 60 mm



Code	Outside Dimension L x W x H
B2-2525	247 x 256 x 5 mm

Silicone Mat



Code	Outside Dimension L x W x H
A7-2525	225 x 235 mm

Reusable Model

Flat Size Baskets

Wire Basket

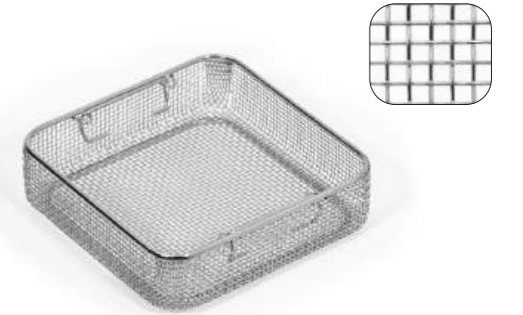

Perforated Basket

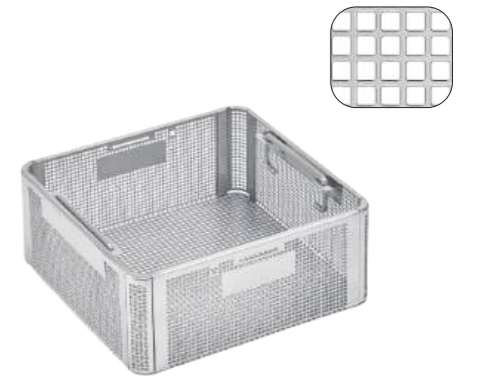

Reusable Model

Mini Size

 Different Lids Colors



With Reusable Mechanism



With Color Options



Code	Outside Dimension Inside Dimension L x W x H
K1-70-70	305 x 135 x 60 mm 272 x 125 x 48 mm
K1-70-100	305 x 135 x 90 mm 272 x 125 x 78 mm
K1-70-130	305 x 135 x 120 mm 272 x 125 x 108 mm

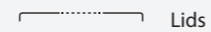

Colors	Code
Grey	K3-70-1
Yellow	K3-70-2
Red	K3-70-3
Blue	K3-70-4
Green	K3-70-5
Black	K3-70-6
Purple	K3-70-7
Bronze	K3-70-8

Dimension
303 x 136 x 29 mm

Wire Basket

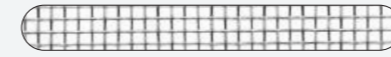

Mesh: 4x4 mm
Wire: ø 1 mm



Code	Outside Dimension L x W x H
B1-2712-40	268 x 117 x 40 mm
B1-2712-100	268 x 117 x 100 mm



Code	Outside Dimension L x W x H
B1-2712	250 x 120 x 5 mm

Perforated Basket



Mesh: 4x4 mm
Wire: ø 1 mm

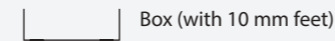

Code	Outside Dimension L x W x H
B2-2712-40	260 x 120 x 50 mm
B2-2712-100	260 x 120 x 110 mm



Code	Outside Dimension L x W x H
B2-2712	262 x 122 x 5 mm

Silicone Mat



Code	Outside Dimension L x W x H
A7-2712	270 x 125 mm

Reusable Model

Mini Size Baskets

Wire Basket



Perforated Basket

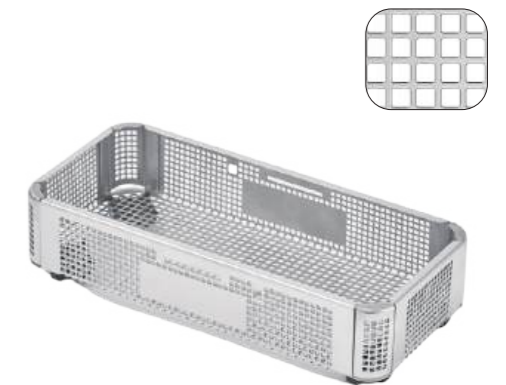

Reusable Model

Dental Size

 Different Lids Colors



With Reusable Mechanism



With Color Options



Code	Outside Dimension Inside Dimension L x W x H
K1-60-70	310 x 189 x 60 mm 277 x 180 x 48 mm
K1-60-100	310 x 189 x 90 mm 277 x 180 x 78 mm
K1-60-130	310 x 189 x 120 mm 277 x 180 x 108 mm



Colors	Code
Grey	K3-60-1
Yellow	K3-60-2
Red	K3-60-3
Blue	K3-60-4
Green	K3-60-5
Black	K3-60-6
Purple	K3-60-7
Bronze	K3-60-8

Dimension
308 x 190 x 29 mm

Wire Basket



Mesh: \varnothing 4x4 mm
Wire: \varnothing 1 mm



Code	Outside Dimension L x W x H
B1-2717-40	270 x 170 x 40 mm
B1-2717-100	270 x 170 x 100 mm



Code
B1-2717
Outside Dimension
L x W x H
252 x 172 x 5 mm

Perforated Basket



Mesh: \varnothing 4x4 mm
Wire: \varnothing 1 mm

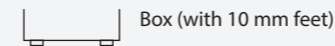

Code	Outside Dimension L x W x H
B2-2717-40	273 x 172 x 50 mm
B2-2717-100	273 x 172 x 110 mm



Code
B2-2717
Outside Dimension
L x W x H
275 x 174 x 5 mm

Reusable Model

Dental Size Baskets

Wire Basket

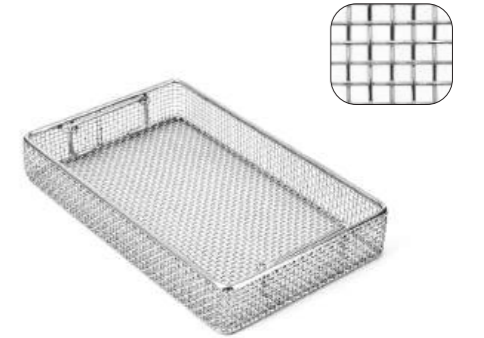

Perforated Basket



Reusable Model

1/2 Dental Size

 Different Lids Colors



With Reusable Mechanism



With Color Options



Code	Outside Dimension Inside Dimension L x W x H
K1-80-70	207 x 144 x 60 mm 174 x 135 x 48 mm
K1-80-100	207 x 144 x 90 mm 174 x 135 x 78 mm
K1-80-130	207 x 144 x 120 mm 174 x 135 x 108 mm



Colors	Code
Grey	K3-80-1
Yellow	K3-80-2
Red	K3-80-3
Blue	K3-80-4
Green	K3-80-5
Black	K3-80-6
Purple	K3-80-7
Bronze	K3-80-8

Dimension
205 x 145 x 29 mm

Wire Basket



Mesh: \varnothing 4x4 mm
Wire: \varnothing 1 mm



Code	Outside Dimension L x W x H
B1-1714-40	165 x 130 x 35 mm
B1-1714-100	165 x 130 x 100 mm



Code	Outside Dimension L x W x H
B1-1714	147 x 132 x 5 mm



Wire Basket

Perforated Basket



Mesh: \varnothing 4x4 mm
Wire: \varnothing 1 mm

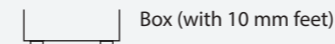

Code	Outside Dimension L x W x H
B2-1714-40	165 x 130 x 45 mm
B2-1714-100	165 x 130 x 110 mm



Code	Outside Dimension L x W x H
B2-1714	167 x 130 x 5 mm



Perforated Basket

Reusable Model

1/2 Dental Size Baskets

Organize.

Sterilize.

Excel.

Holding the
Standard



Three Different Types of Basket
Models by Construction/Material



Perforated
Sheet
Ø 1 mm
□ 4 mm

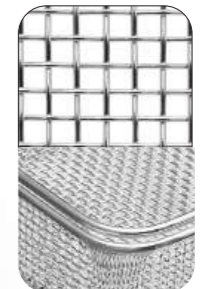

Wire Mesh
Ø 1 mm
□ 4 mm

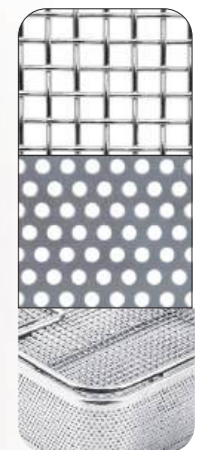

Hybrith
Ø 1 mm
□ 4 mm
Side Mesh
Ø 3 mm

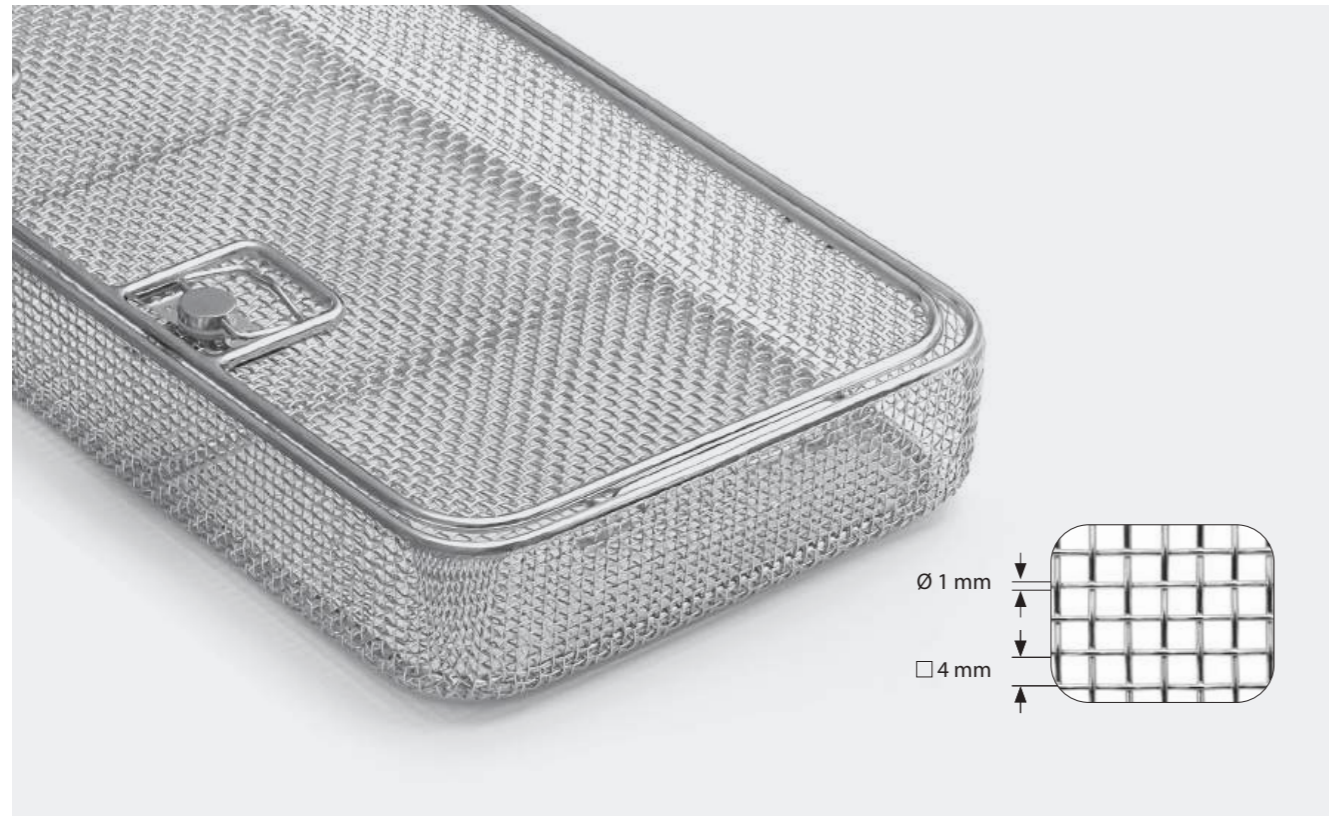

Half Size



Box Code	Outside Dimension L x W x H
B1-2525-30	246 x 246 x 30 mm
B1-2525-50	246 x 246 x 50 mm
B1-2525-70	246 x 246 x 70 mm
B1-2525-100	246 x 246 x 100 mm

Lid Code	Outside Dimension L x W x H
B1-2525	240 x 215 x 5 mm

Long Size

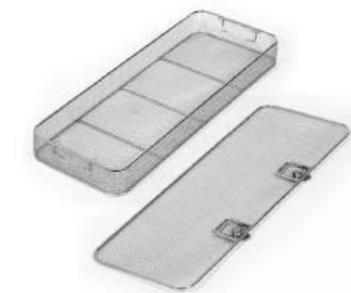

Box Code	Outside Dimension L x W x H
B1-6625-50	665 x 245 x 50 mm
B1-6625-70	665 x 245 x 70 mm
B1-6625-100	665 x 245 x 100 mm
-	-

Lid Code	Outside Dimension L x W x H
B1-6625	635 x 230 x 5 mm

Wide Size

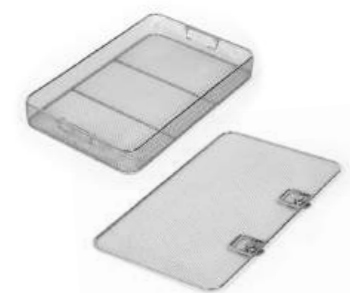

Box Code	Outside Dimension L x W x H
B1-5333-50	533 x 337 x 50 mm
B1-5333-70	533 x 337 x 70 mm
B1-5333-100	533 x 337 x 100 mm
-	-

Lid Code	Outside Dimension L x W x H
B1-5333	503 x 322 x 5 mm

Full Size

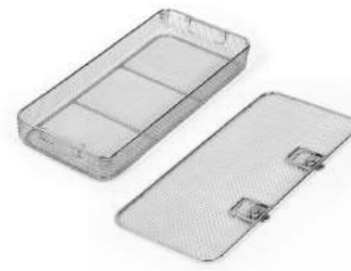

Box Code	Outside Dimension L x W x H
B1-5425-30	540 x 245 x 30 mm
B1-5425-50	540 x 245 x 50 mm
B1-5425-70	540 x 245 x 70 mm
B1-5425-100	540 x 245 x 100 mm

Lid Code	Outside Dimension L x W x H
B1-5425	510 x 230 x 5 mm

Din Size



Box Code	Outside Dimension L x W x H
B1-4825-30	480 x 245 x 30 mm
B1-4825-50	480 x 245 x 50 mm
B1-4825-70	480 x 245 x 70 mm
B1-4825-100	480 x 245 x 100 mm

Lid Code	Outside Dimension L x W x H
B1-4825	450 x 230 x 5 mm

Quarter Size



Box Code	Outside Dimension L x W x H
B1-4025-30	405 x 245 x 30 mm
B1-4025-50	405 x 245 x 50 mm
B1-4025-70	405 x 245 x 70 mm
B1-4025-100	405 x 245 x 100 mm

Lid Code	Outside Dimension L x W x H
B1-4025	375 x 230 x 5 mm

Dental Size

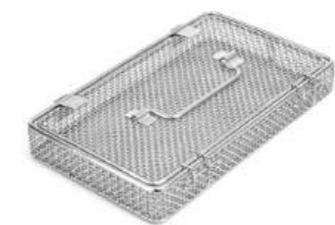

Box Code	Outside Dimension L x W x H
B1-2717-40	270 x 170 x 40 mm
B1-2717-100	270 x 170 x 100 mm
-	-
-	-

Lid Code	Outside Dimension L x W x H
B1-2717	252 x 172 x 5 mm

Mini Size



Box Code	Outside Dimension L x W x H
B1-2712-40	268 x 117 x 40 mm
B1-2712-100	268 x 117 x 100 mm
-	-
-	-

Lid Code	Outside Dimension L x W x H
B1-2712	250 x 120 x 5 mm

Dental 1/2



Box Code	Outside Dimension L x W x H
B1-1714-40	165 x 130 x 35 mm
B1-1714-100	165 x 130 x 100 mm
-	-
-	-

Lid Code	Outside Dimension L x W x H
B1-1714	147 x 132 x 5 mm

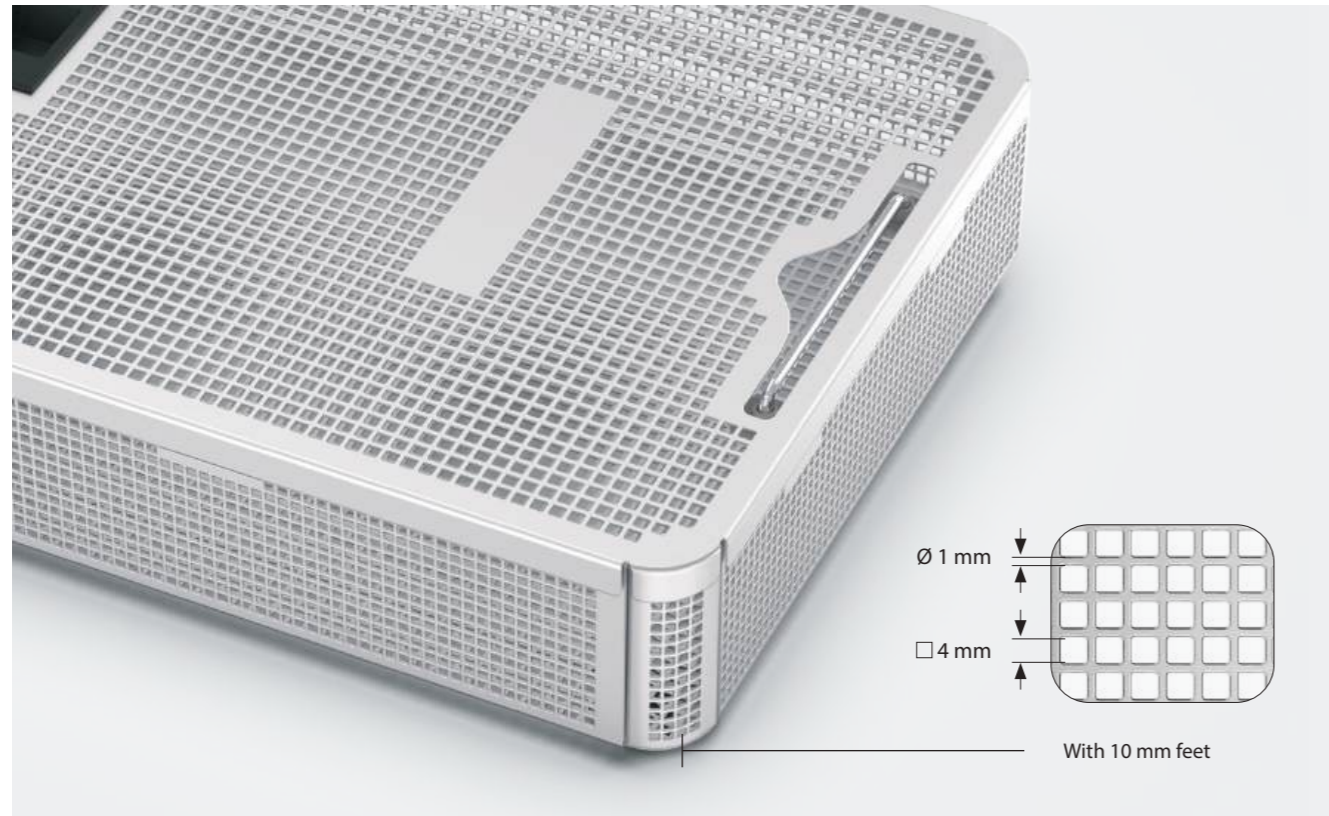

Half Size		Long Size		Wide Size	
Box Code	Outside Dimension L x W x H	Box Code	Outside Dimension L x W x H	Box Code	Outside Dimension L x W x H
B2-2525-30	244 x 250 x 40 mm	B2-6625-30	650 x 251 x 40 mm	B2-5333-30	535 x 340 x 40 mm
B2-2525-50	244 x 250 x 60 mm	B2-6625-50	650 x 251 x 60 mm	B2-5333-50	535 x 340 x 60 mm
B2-2525-70	244 x 250 x 80 mm	B2-6625-70	650 x 251 x 80 mm	B2-5333-70	535 x 340 x 80 mm
B2-2525-100	244 x 250 x 110 mm	B2-6625-100	650 x 251 x 110 mm	B2-5333-100	535 x 340 x 110 mm
Lid Code	Outside Dimension L x W x H	Lid Code	Outside Dimension L x W x H	Lid Code	Outside Dimension L x W x H
B2-2525	247 x 256 x 5 mm	B2-6625	652 x 256 x 5 mm	B2-5333	537 x 343 x 5 mm

Full Size		Din Size		Quarter Size	
Box Code	Outside Dimension L x W x H	Box Code	Outside Dimension L x W x H	Box Code	Outside Dimension L x W x H
B2-5425-30	540 x 251 x 40 mm	B2-4825-30	483 x 251 x 40 mm	B2-4025-30	403 x 251 x 40 mm
B2-5425-50	540 x 251 x 60 mm	B2-4825-50	483 x 251 x 60 mm	B2-4025-50	403 x 251 x 60 mm
B2-5425-70	540 x 251 x 80 mm	B2-4825-70	483 x 251 x 80 mm	B2-4025-70	403 x 251 x 80 mm
B2-5425-100	540 x 251 x 110 mm	B2-4825-100	483 x 251 x 110 mm	B2-4025-100	403 x 251 x 110 mm
Lid Code	Outside Dimension L x W x H	Lid Code	Outside Dimension L x W x H	Lid Code	Outside Dimension L x W x H
B2-5425	540 x 256 x 5 mm	B2-4825	485 x 256 x 5 mm	B2-4025	405 x 256 x 5 mm

Dental Size		Mini Size		Dental 1/2	
Box Code	Outside Dimension L x W x H	Box Code	Outside Dimension L x W x H	Box Code	Outside Dimension L x W x H
B2-2717-40	273 x 172 x 50 mm	B2-2712-40	260 x 120 x 50 mm	B2-1714-40	165 x 130 x 45 mm
B2-2717-100	273 x 172 x 110 mm	B2-2712-100	260 x 120 x 110 mm	B2-1714-100	165 x 130 x 110 mm
-	-	-	-	-	-
-	-	-	-	-	-
Lid Code	Outside Dimension L x W x H	Lid Code	Outside Dimension L x W x H	Lid Code	Outside Dimension L x W x H
B2-2717	275 x 174 x 5 mm	B2-2712	262 x 122 x 5 mm	B2-1714	167 x 130 x 5 mm



Half Size		Long Size		Wide Size	
Box Code	Outside Dimension L x W x H	Box Code	Outside Dimension L x W x H	Box Code	Outside Dimension L x W x H
B3-2525-50	245 x 255 x 50 mm	B3-6625-50	665 x 255 x 50 mm	B3-5333-50	533 x 337 x 50 mm
B3-2525-70	245 x 255 x 70 mm	B3-6625-70	665 x 255 x 70 mm	B3-5333-70	533 x 337 x 70 mm
B3-2525-100	245 x 255 x 100 mm	B3-6625-100	665 x 255 x 100 mm	B3-5333-100	533 x 337 x 100 mm
Lid Code	Outside Dimension L x W x H	Lid Code	Outside Dimension L x W x H	Lid Code	Outside Dimension L x W x H
B3-2525	215 x 240 x 5 mm	B3-6625	635 x 240 x 5 mm	B3-5333	503 x 322 x 5 mm

Fine Mesh Baskets

Full Size		Din Size		Quarter Size	
Box Code	Outside Dimension L x W x H	Box Code	Outside Dimension L x W x H	Box Code	Outside Dimension L x W x H
B3-5425-50	540 x 255 x 50 mm	B3-4825-50	485 x 255 x 50 mm	B3-4025-50	405 x 255 x 50 mm
B3-5425-70	540 x 255 x 70 mm	B3-4825-70	485 x 255 x 70 mm	B3-4025-70	405 x 255 x 70 mm
B3-5425-100	540 x 255 x 100 mm	B3-4825-100	485 x 255 x 100 mm	B3-4025-100	405 x 255 x 100 mm
Lid Code	Outside Dimension L x W x H	Lid Code	Outside Dimension L x W x H	Lid Code	Outside Dimension L x W x H
B3-5425	510 x 240 x 5 mm	B3-4825	455 x 240 x 5 mm	B3-4025	375 x 240 x 5 mm

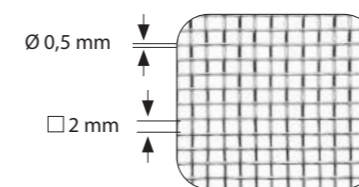
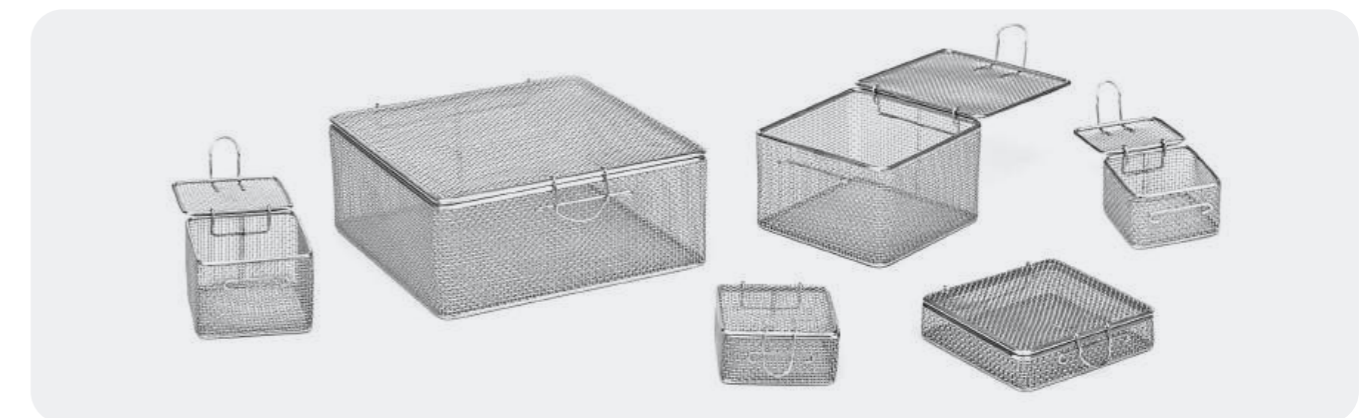

Box Code	Outside Dimension L x W x H	Box Code	Outside Dimension L x W x H
B4-33-30	30 x 30 x 30 mm	B4-88-40	80 x 80 x 40 mm
B4-44-20	40 x 40 x 20 mm	B4-88-60	80 x 80 x 60 mm
B4-66-20	60 x 60 x 20 mm	B4-1212-30	120 x 120 x 30 mm
B4-66-40	60 x 60 x 40 mm	B4-1212-60	120 x 120 x 60 mm
B4-84-40	80 x 40 x 40 mm	B4-2424-60	240 x 240 x 60 mm



 Bottom With Lid
W/O Feet
Wire: \varnothing 1 mm
Mesh: 4x4 mm

Code	Dimension L x W x H	Code	Dimension L x W x H
B2-2718-32	275 x 180 x 32 mm	B2-188-32	188 x 86 x 32 mm
B2-2718-42	275 x 180 x 42 mm	B2-144-28	146 x 46 x 28 mm
B2-247-30	240 x 76 x 30 mm	B2-84-28	86 x 46 x 28 mm
B2-1913-34	191 x 130 x 34 mm		

STU - SPRI Baskets

Wire Basket
Single Scope

Code
B5-298-55-S

Dimension
L x W x H
290 x 80 x 52 mm

Code
B5-468-55-S

Dimension
L x W x H
460 x 80 x 52 mm

Wire Basket
Double Scope

Code
B5-298-55-D

Dimension
L x W x H
290 x 80 x 52 mm

Code
B5-468-55-D

Dimension
L x W x H
460 x 80 x 52 mm

Perforated Basket
Single Scope

Code
B5-278-44-S

Dimension
L x W x H
272 x 83 x 44 mm

Code
B5-458-44-S

Dimension
L x W x H
452 x 83 x 44 mm

Perforated Basket
Double Scope

Code
B5-2710-44-D

Dimension
L x W x H
272 x 103 x 44 mm

Code
B5-4510-44-D

Dimension
L x W x H
452 x 103 x 44 mm



STU Baskets

Box Code	Outside Dimension L x W x H	Details
B7-5728-135	575 x 280 x 135 mm	Upper Frame: \varnothing 6 mm
B7-5728-265	575 x 280 x 265 mm	Body Wires: \varnothing 2 & 3 mm Base Frame \varnothing 5 mm

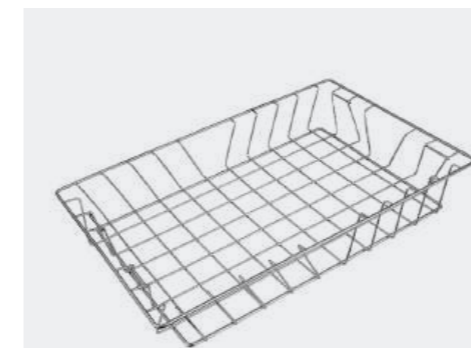

SPRI Baskets

Box Code	Outside Dimension L x W x H	Details
B8-6030-40	600x300x40 mm	Main Frame: \varnothing 6 mm
B8-6030-100	600x300x100 mm	Body Wire: \varnothing 4 mm
B8-6030-150	600x300x150 mm	Base Frame \varnothing 5 mm
B8-6040-100	600x400x100 mm	Single Frame Stackable
B8-6040-150	600x400x150 mm	
B8-6040-200	600x400x200 mm	



Paper Filters		PTFE Teflon Filters	
Code A1-10-1 For: 1/1, 3/4, 1/2, Long, Wide Size: Ø 185 mm	Code A1-11-1 For: Small Size Containers Size: Ø 88 mm	Code A1-20-1 For: 1/1, 3/4, 1/2, Long, Wide Size: Ø 190 mm Cycle: 2000 Cycles Reusable	Code A1-21-1 For: Small Size Containers Size: Ø 88 mm Cycle: 2000 Cycles Reusable
Code A1-20-2 For: 1/1, 3/4, 1/2, Long, Wide Size: Ø 190 mm Cycle: 1200 Cycles Reusable	Code A1-21-2 For: Small Size Containers Size: Ø 88 mm Cycle: 1200 Cycles Reusable	Material 73g/m ² Medical Grade Paper Package 100 pcs Sterilization Steam Cycle Single Use	

Polymer Security Seals		Polymer Security Seals With Indicator	
Code A2-10-1 Package 100 pcs Sterilization Steam Cycle Single Use Color Blue	Code A2-20-1 Package 100 pcs Sterilization Steam Cycle Single Use Color Red	Code A2-10-2 Package 100 pcs Sterilization Steam Cycle Single Use Color Blue	Code A2-20-2 Package 100 pcs Sterilization Steam Cycle Single Use Color Red



Identification Labels				Filter Retainers	
Color	Code	Color	Code		
	A5-10-1		A5-10-5	Code A6-10-1 For: 1/1, 3/4, 1/2, Long, Wide	Code A6-10-2 For: Small Size Containers
	A5-10-2		A5-10-6		
	A5-10-3		A5-10-7		
	A5-10-4		A5-10-8		
Material 1,5 mm Aluminum Package 1 Piece Sterilization Steam Marking Maximum 24 Letters				Material Stainless Steel Package 1 piece	

Paper Labels			
		Material Paper	Size Big & Small
Code A3-10-1 with indicator	Code A3-10-2 with indicator	Package 100 pcs	Sterilization Steam

Silicone Mats & Nets					
	Code A7-5425	Size 500 X 235 mm		Code A4-5425	Size 540 x 252 mm
	Code A7-4025	Size 370 X 235 mm		Code A4-4025	Size 420 x 252 mm
	Code A7-2525	Size 225 x 235 mm		Code A4-2525	Size 254 x 253 mm
	Code A7-2712	Size 270 x 125 mm			
h: 14 mm h: 5 mm h: 2 mm				Material Medical Grade Silicone Package 1 Piece Sterilization Steam Color Light Blue	

Silicone Gasket							
	Code A11-10-1	Size 1/1 Full	Code A11-40-1	Size Long	Code A11-70-1	Size Mini	Material Medical Grade Sealing Silicone
	Code A11-20-1	Size 3/4 Quarter	Code A11-50-1	Size Wide	Code A11-80-1	Size 1/2 Dental	Package 1 Piece
	Code A11-30-1	Size 1/2 Half	Code A11-60-1	Size Dental	Code A11-90-1	Size Flat	Shape D shape, Jointless
							Feature Place & Go, No Glue Required



Code T1-10-1
 Material : Stainless Steel
 Feet : 4 wheels - 2 braked
 Package : 1 Piece
 Dimensions: 600 x 860 x 900 mm (W x L x H)



Code T1-10-2
 Material : Stainless Steel
 Feet : 4 wheels - 2 braked
 Package : 1 Piece
 Dimensions: 550 x 860 x 900 mm (W x L x H)



Code T1-10-3
 Material : Stainless Steel
 Feet : 4 wheels - 2 braked
 Package : 1 Piece
 Dimensions: 600 x 850 x 900 mm (W x L x H)



Code T1-10-4
 Material : Stainless Steel
 Feet : 4 wheels - 2 braked
 Package : 1 Piece
 Dimensions: 550 x 860 x 900 mm (W x L x H)



Code T1-10-5
 Material : Stainless Steel
 Feet : 4 Adjustable Leveling Feet
 Package : 1 Piece
 Dimensions: 600 x 1400 x 850 mm (W x L x H)



Code T1-10-6
 Material : Stainless Steel
 Feet : 4 wheels - 2 braked
 Package : 1 Piece
 Dimensions: 700 x 360 x 1350 mm (W x L x H)

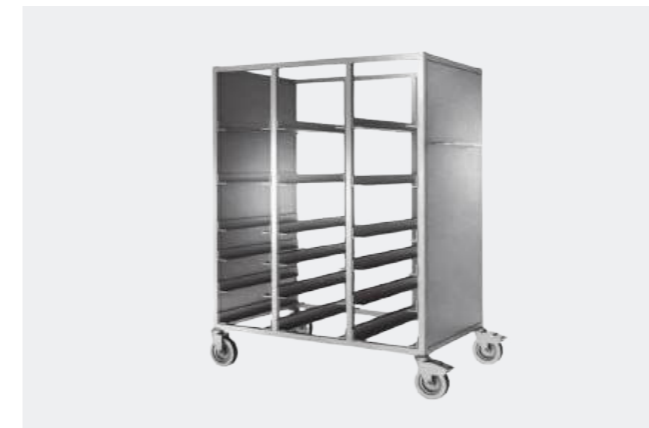

Code T1-10-7
 Material : Stainless Steel
 Feet : 4 wheels - 2 braked
 Package : 1 Piece
 Dimensions: 700 x 1080 x 1350 mm (W x L x H)



Code T1-10-8
 Material : Stainless Steel
 Feet : 4 wheels - 2 braked
 Package : 1 Piece - including 3 baskets
 Dimensions: 400 x 600 x 1700 (W x L x H)

Numerical Index

Code	Page	Code	Page	Code	Page	Code	Page
A1-10-1	68	B1-6625-100	25, 47, 61	B3-5425-50	19, 41, 65	K1-30-6	22
A11-10-1	69	B1-6625-50	25, 47, 61	B3-5425-70	19, 41, 65	K1-30-7	22
A1-11-1	68	B1-6625-70	25, 47, 61	B3-6625	25, 47, 65	K1-30-8	22
A11-20-1	69	B2-144-28	67	B3-6625-100	25, 47, 65	K1-40-1	24
A11-30-1	69	B2-1714	35, 57, 63	B3-6625-50	25, 47, 65	K1-40-150	24, 46
A11-40-1	69	B2-1714-100	35, 57, 63	B3-6625-70	25, 47, 65	K1-40-2	24
A11-50-1	69	B2-1714-40	35, 57, 63	B4-1212-30	65	K1-40-200	24, 46
A11-60-1	69	B2-188-32	67	B4-1212-60	65	K1-40-3	24
A11-70-1	69	B2-1913-34	67	B4-2424-60	65	K1-40-4	24
A11-80-1	69	B2-247-30	67	B4-33-30	65	K1-40-5	24
A11-90-1	69	B2-2525	23, 29, 45, 51, 61	B4-44-20	65	K1-40-6	24
A1-20-1	68	B2-2525-100	23, 45, 61	B4-66-20	65	K1-40-7	24
A1-21-1	68	B2-2525-30	23, 29, 45, 51, 61	B4-66-40	65	K1-40-8	24
A2-10-1	68	B2-2525-50	23, 29, 45, 51, 61	B4-84-40	65	K1-50-1	26
A2-10-2	68	B2-2525-70	23, 45, 61	B4-88-40	65	K1-50-110	26, 48
A2-20-1	68	B2-2712	31, 53, 63	B4-88-60	65	K1-50-170	26, 48
A2-20-2	68	B2-2712-100	31, 53, 63	B5-2710-44-D	66	K1-50-2	26
A3-10-1	69	B2-2712-40	31, 53, 63	B5-278-44-S	66	K1-50-3	26
A3-10-2	69	B2-2717	35, 57, 63	B5-298-55-D	66	K1-50-4	26
A5-10-1	69	B2-2717-100	35, 57, 63	B5-298-55-S	66	K1-50-5	26
A5-10-2	69	B2-2717-40	35, 57, 63	B5-4510-44-D	66	K1-50-6	26
A5-10-3	69	B2-2718-32	67	B5-458-44-S	66	K1-50-7	26
A5-10-4	69	B2-2718-42	67	B5-468-55-S	66	K1-50-8	26
A5-10-5	69	B2-4025	21, 43, 62	B5-468-55-D	66	K1-60-1	32
A5-10-6	69	B2-4025-100	21, 43, 62	B7-5728-135	67	K1-60-100	32, 54
A5-10-7	69	B2-4025-30	21, 43, 62	B7-5728-265	67	K1-60-130	32, 54
A5-10-8	69	B2-4025-50	21, 43, 62	B8-6030-100	67	K1-60-2	32
A6-10-1	69	B2-4025-70	21, 43, 62	B8-6030-150	67	K1-60-3	32
A6-10-2	69	B2-4825	62	B8-6030-40	67	K1-60-4	32
A7-2525	22, 29, 45, 51, 69	B2-4825-100	62	B8-6040-100	67	K1-60-40	32
A7-2712	31, 53, 69	B2-4825-30	62	B8-6040-150	67	K1-60-5	32
A7-4025	21, 43, 69	B2-4825-50	62	B8-6040-200	67	K1-60-6	32
A7-5425	19, 41, 69	B2-4825-70	62	K1-10-1	18	K1-60-7	32
B1-1714	35, 57, 63	B2-5333	27, 49, 63	K1-10-110	18, 40	K1-60-70	32, 55
B1-1714-100	35, 57, 63	B2-5333-100	27, 49, 63	K1-10-135	18, 40	K1-60-8	32
B1-1714-40	35, 57, 63	B2-5333-30	27, 49, 63	K1-10-150	18, 40	K1-70-1	32
B1-2525	23, 29, 45, 51, 61, 65	B2-5333-50	27, 49, 63	K1-10-2	18	K1-70-100	32, 55
B1-2525-100	23, 45, 61	B2-5333-70	27, 49, 63	K1-10-200	18, 40	K1-70-130	32, 55
B1-2525-30	23, 29, 45, 51, 61	B2-5425	19, 41, 62	K1-10-260	18, 40	K1-70-2	32
B1-2525-50	23, 29, 45, 51, 61	B2-5425-100	19, 41, 62	K1-10-3	18	K1-70-3	32
B1-2525-70	23, 45, 61	B2-5425-30	19, 41, 62	K1-10-4	18	K1-70-4	32
B1-2712	31, 53, 61	B2-5425-50	19, 41, 62	K1-10-5	18	K1-70-40	32
B1-2712-100	31, 53, 61	B2-5425-70	19, 41, 62	K1-10-6	18	K1-70-5	3232
B1-2712-40	31, 53, 61	B2-6625	25, 47, 63	K1-10-7	18	K1-70-6	32
B1-2717	33, 55, 61	B2-6625-100	25, 47, 63	K1-10-8	18	K1-70-7	32
B1-2717-100	33, 55, 61	B2-6625-30	25, 47, 63	K1-20-1	20	K1-70-70	32, 55
B1-2717-40	33, 55, 61	B2-6625-50	25, 47, 63	K1-20-110	20, 42	K1-70-8	32
B1-4025	21, 43, 60, 64	B2-6625-70	25, 47, 63	K1-20-135	20, 42	K1-80-1	34
B1-4025-100	21, 43, 60	B2-84-28	67	K1-20-150	20, 42	K1-80-100	34, 56
B1-4025-30	21, 43, 60	B3-2525	23, 45, 65	K1-20-2	20	K1-80-130	34, 56
B1-4025-50	21, 43, 60	B3-2525-100	23, 45, 65	K1-20-200	20, 42	K1-80-2	34
B1-4025-70	21, 43, 60	B3-2525-50	23, 45, 65	K1-20-3	20	K1-80-3	34
B1-4825	60, 64	B3-2525-70	23, 45, 65	K1-20-4	20	K1-80-4	34
B1-4825-100	60	B3-4025	21, 45, 65	K1-20-5	20	K1-80-40	34
B1-4825-30	60	B3-4025-100	21, 43, 65	K1-20-6	20	K1-80-5	34
B1-4825-50	60	B3-4025-50	21, 43, 65	K1-20-7	20	K1-80-6	34
B1-4825-70	60	B3-4025-70	21, 43, 65	K1-20-8	20	K1-80-7	34
B1-5333	27, 49, 61	B3-4825	67	K1-30-1	22	K1-80-70	34, 56
B1-5333-100	27, 49, 61	B3-4825-100	67	K1-30-110	22, 44	K1-80-8	34
B1-5333-50	27, 49, 61	B3-4825-50	67	K1-30-135	22, 44	K1-90-1	28
B1-5333-70	27, 49, 61	B3-4825-70	67	K1-30-150	22, 44	K1-90-2	28
B1-5425	19, 41, 60, 64	B3-5333	27, 49, 65	K1-30-2	22	K1-90-3	28
B1-5425-100	19, 41, 60	B3-5333-100	27, 49, 65	K1-30-200	22, 44	K1-90-4	28
B1-5425-30	19, 41, 60	B3-5333-50	27, 49, 65	K1-30-260	22, 44	K1-90-45	28
B1-5425-50	19, 41, 60	B3-5333-70	27, 49, 65	K1-30-3	22	K1-90-5	28
B1-5425-70	19, 41, 60	B3-5425	19, 41, 65	K1-30-4	22	K1-90-6	28
B1-6625	25, 47, 61, 65	B3-5425-100	19, 41, 65	K1-30-5	22	K1-90-7	28

Numerical Index

Code	Page	Code	Page	Code	Page
K1-90-75	28, 50	K3-40-2	46	KS1-10-3	18
K1-90-8	28	K3-40-3	46	KS1-10-4	18
K2-10-1	40	K3-40-4	46	KS1-10-5	18
K2-10-2	40	K3-40-5	46	KS1-10-6	18
K2-10-3	40	K3-40-6	46	KS1-10-7	18
K2-10-4	40	K3-40-7	46	KS1-10-8	18
K2-10-5	40	K3-40-8	46	KS1-20-1	20
K2-10-6	40	K3-50-1	48	KS1-20-2	20
K2-10-7	40	K3-50-2	48	KS1-20-3	20
K2-10-8	40	K3-50-3	48	KS1-20-4	20
K2-20-1	42	K3-50-4	48	KS1-20-5	20
K2-20-2	42	K3-50-5	48	KS1-20-6	20
K2-20-3	42	K3-50-6	48	KS1-20-7	20
K2-20-4	42	K3-50-7	48	KS1-20-8	20
K2-20-5	42	K3-50-8	48	KS1-30-1	22
K2-20-6	42	K3-60-1	54	KS1-30-2	22
K2-20-7	42	K3-60-2	54	KS1-30-3	22
K2-20-8	42	K3-60-3	54	KS1-30-4	22
K2-30-1	44	K3-60-4	54	KS1-30-5	22
K2-30-2	44	K3-60-5	54	KS1-30-6	22
K2-30-3	44	K3-60-6	54	KS1-30-7	22
K2-30-4	44	K3-60-7	54	KS1-30-8	22
K2-30-5	44	K3-60-8	54	T1-10-1	70
K2-30-6	44	K3-70-1	52	T1-10-2	70
K2-30-7	44	K3-70-2	52	T1-10-3	70
K2-30-8	44	K3-70-3	52	T1-10-4	70
K2-40-1	46	K3-70-4	52	T1-10-5	71
K2-40-2	46	K3-70-5	52	T1-10-6	71
K2-40-3	46	K3-70-6	52	T1-10-7	71
K2-40-4	46	K3-70-7	52	T1-10-8	71
K2-40-5	46	K3-70-8	52		
K2-40-6	46	K3-80-1	56		
K2-40-7	46	K3-80-2	56		
K2-40-8	46	K3-80-3	56		
K2-50-1	48	K3-80-4	56		
K2-50-2	48	K3-80-5	56		
K2-50-3	48	K3-80-6	56		
K2-50-4	48	K3-80-7	56		
K2-50-5	48	K3-80-8	56		
K2-50-6	48	K3-90-1	50		
K2-50-7	48	K3-90-2	50		
K2-50-8	48	K3-90-3	50		
K3-10-1	40	K3-90-4	50		
K3-10-2	40	K3-90-5	50		
K3-10-3	40	K3-90-6	50		
K3-10-4	40	K3-90-7	50		
K3-10-5	40	K3-90-8	50		
K3-10-6	40	KP1-10-110	18		
K3-10-7	40	KP1-10-135	18		
K3-10-8	40	KP1-10-150	18		
K3-20-1	42	KP1-10-200	18		
K3-20-2	42	KP1-10-260	18		
K3-20-3	42	KP1-20-110	20		
K3-20-4	42	KP1-20-135	20		
K3-20-5	42	KP1-20-150	20		
K3-20-6	42	KP1-20-200	20		
K3-20-7	42	KP1-30-110	22		
K3-20-8	42	KP1-30-135	22		
K3-30-1	44	KP1-30-150	22		
K3-30-2	44	KP1-30-200	22		
K3-30-3	44	KP1-30-260	22		
K3-30-4	44	KP1-40-150	24		
K3-30-5	44	KP1-40-200	24		
K3-30-6	44	KP1-50-110	26		
K3-30-7	44	KP1-50-170	26		
K3-30-8	44	KS1-10-1	18		
K3-40-1	46	KS1-10-2	18		



İstiklal Mah. 58. Sokak
No: 61 PK: 55310
Tekkeköy/Samsun/Türkiye

+90 362 363 00 01
victorishealth.com
info@victorishealth.com

Secure Today
Elevate Tomorrow

